

---

TRUST FLAIR  
TRUST PRO

# THE ULTIMATE EASY FIT SHOWERING SOLUTIONS

NI - MARCH 2026



# PRO



ESSENTIAL COLLECTIONS  
TECHNICAL

[FLAIRSHOWERS.COM](http://FLAIRSHOWERS.COM)

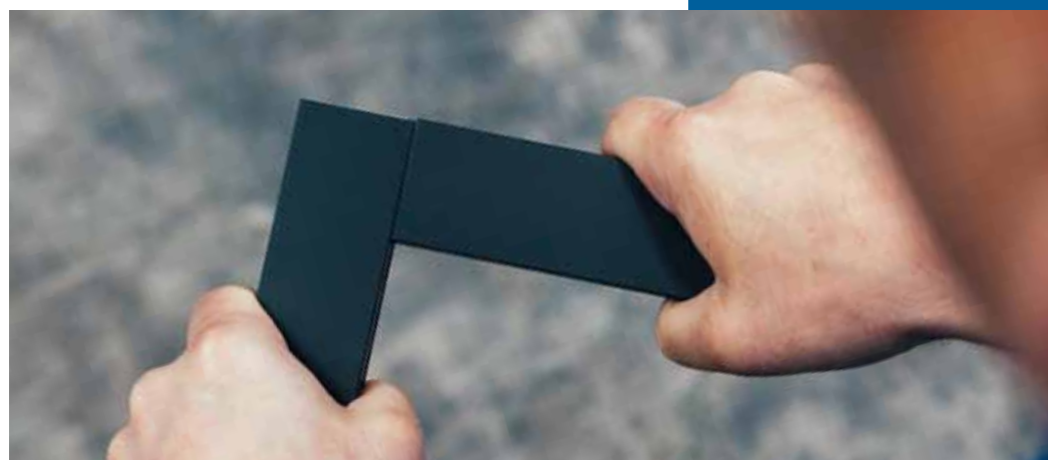

HAVE YOU  
CLICKED YET?



# EXCEPTIONAL EVERYDAY.

Flair has been designing showering solutions for over 70 years and perfecting them since. Our products are beautifully designed and expertly engineered to stand the test of time in the busiest of bathrooms. At Flair our vision is to produce beautifully designed, expertly crafted showering solutions for every customer, every budget, style & space.

The tradition of design excellence continues with the launch of our Flair PRO Essential Collections; an extensive portfolio of shower enclosures, wetrooms, and bathscreens that are tailored to meet the exacting demands of trade professionals.

Flair PRO Essential Collections are engineered for quick installation without having to compromise on quality, look and feel. We are trusted for our commitment to delivering innovative solutions that make your job quicker and easier.

All backed by Flair's 20 year guarantee.



TRUST FLAIR  
TRUST PRO





# THE ULTIMATE EASY FIT SHOWERING SOLUTIONS

## ■ *Easy to fit*

Flair's professional grade showering solutions have been developed to be quick and easy to fit. Our innovative installation designs mean that frames can be quickly put into place. We also provide user-friendly instructions and generous adjustments.

## ■ *Built to last*

We invest in product design, materials and quality control to make sure our products stand the test of time and provide a true fit-and-forget solution.

## ■ *Unrivalled choice*

Our showering collections have something for every customer, every budget, style and space.

## ■ *Exceptional customer support*

The success of Flair has been built upon exceptional service and support. From advising on product selection to quickly finding spare parts, our friendly team are here to help.



Scan the code to visit our YouTube channel and view the Installation Videos

# CONTENTS

VERVE PRO 8	12
VERVE PRO	22
VERVE WETROOMS	40
VERVE BATHSCREENS	44
HYDRO EXPRESS	54
FLAIR FRAMELESS	66
SLIMLINE CAPELLA	78
SOUL Premium Grab Bar Collection	91
SHOWER TRAYS	98
SPECIFICATION COMPARISON	114

**EXCEPTIONAL**  
*EVERYDAY.*



*FIND YOUR FLAIR.*

THE  
DIFFERENCE  
IS CLEAR!

8mm  
TOUGHENED  
SAFETY GLASS



6mm  
TOUGHENED  
SAFETY GLASS



# VERVE PRO

THE **ULTIMATE EASY FIT**  
SHOWERING SOLUTIONS  
AVAILABLE IN **8MM & 6MM**  
TOUGHENED SAFETY GLASS

Our Verve shower enclosures feature a Click Fit PRO assembly system that is expertly engineered to simplify life for trade professionals. Designed for fast, secure, and hassle-free setup, it provides the ultimate solution for quick, easy, and reliable installations.

Combining practicality with quality and professional aesthetics, the Verve Click Fit PRO system reflects Flair Showers' dedication to delivering seamless performance for both trade professionals and homeowners alike.



UP TO  
**8mm**  
TOUGHENED  
SAFETY GLASS

## VERVE PRO 8

Designed for everyday luxury, the Verve PRO 8 boasts up to 8mm robust glass, quick installation, and a choice of Silver, Matte Black, or Brushed Brass finishes.

- SILVER
- MATTE BLACK
- BRUSHED BRASS

**6mm**  
TOUGHENED  
SAFETY GLASS

## VERVE PRO

Trusted for everyday bathrooms, the Verve PRO features durable 6mm glass and the Click Fit PRO system, offering effortless style in Silver and Matte Black.

- SILVER
- MATTE BLACK

# CLICK FIT PRO

## Step 1

Align the horizontal profile and vertical shower door profiles together so they are in a straight upward position.



flair  
PRO  
The Hallmark  
of Innovation



## Step 2

Slide the pre-assembled click-fit PRO bracket into place on the vertical profile so the snap hook smoothly locks into the snap fit access port, connecting the two profiles and forming a secure screw-free joint.



Engineered for  
**VERVE PRO 8 + VERVE PRO**  
(where applicable)

# SCREW-FREE ASSEMBLY SYSTEM FOR QUICK & EASY INSTALLATION.

INSTALLERS  
CHOICE

Horizontal  
Profile

Click Fit  
Pro Bracket

Snap Hook

Snap Fit  
Access Port

Vertical  
Profile

DESIGNED FOR  
EVERYDAY LUXURY.



INTRODUCING

## VERVE PRO 8

Introducing Verve PRO 8 – a collection designed to elevate your daily showering ritual with a touch of luxury.

Crafted with up to 8mm toughened glass, it blends strength with a sleek, professional aesthetic.

Engineered with Click Fit PRO, Verve PRO 8 ensures fast, seamless installation for trade professionals who demand quality.

FINISHES:

SILVER

MATTE BLACK

BRUSHED BRASS

KEY FEATURES:

<p>UP TO <b>8mm</b> TOUGHENED SAFETY GLASS</p>	<p>↑ ↓ <b>1950mm</b> HEIGHT</p>	<p>UP TO <b>50mm</b> PRODUCT ADJUSTMENT</p>	
<p>HANDLE ON INSIDE AND OUTSIDE OF ENCLOSURE FOR EASE OF OPENING</p>	<p>⤵ POSITIVE MAGNETIC CLOSE ACTION</p>	<p>👁️ CLEARVUE GLASS COATING</p>	<p>🛞 QUICK RELEASE CHROME DOUBLE WHEEL ROLLERS</p>
<p>↑ 30mm WALL PROFILE EXTENSION AVAILABLE</p>	<p>🏠 CHROME PLATED COVER CAPS</p>	<p>↻ REVERSIBLE FOR LEFT OR RIGHT HANDED INSTALLATION</p>	<p>❤️ 20 YEAR GUARANTEE</p>

SILVER

MATTE BLACK

BRUSHED BRASS



DESIGNED FOR  
EVERYDAY LUXURY.

VERVE PRO 8

# VERVE PRO 8

## 1 DOOR QUADRANT & 1 DOOR OFFSET QUADRANT

**CLICK FIT**  
**PRO**

FINISHES:

SILVER

MATTE BLACK

BRUSHED BRASS



1 DOOR OFFSET QUADRANT - BRUSHED BRASS

HANDLE DETAIL - BRUSHED BRASS



### VERVE PRO 8 – 1 DOOR QUADRANT

SIZE (mm)	ADJUSTMENT SIZE		ACCESS (mm)	CODE	CODE	CODE
	MIN (mm)	MAX (mm)		SILVER	BLACK	BRUSHED BRASS
900	870	895	490	V8OCQ90SC	V8OCQ90BC	V8OCQ90BRBC

### VERVE PRO 8 – 1 DOOR OFFSET QUADRANT

SIZE (mm)	ADJUSTMENT SIZE		ACCESS (mm)	CODE	CODE	CODE
	MIN (mm)	MAX (mm)		SILVER	BLACK	BRUSHED BRASS
800 x 1000	770-795	970-995	490	V8OCQ80X100SC	-	-
800 x 1200	770-795	1170-1195	490	V8OCQ80X120SC	V8OCQ80X120BC	V8OCQ80X120BRBC
900 x 1200	870-895	1170-1195	490	V8OCQ90X120SC	V8OCQ90X120BC	V8OCQ90X120BRBC

\*All Flair Quadrant and Offset Quadrant trays have a 550mm radius.



DESIGNED FOR  
EVERYDAY LUXURY.

1 DOOR QUADRANT - MATTE BLACK

# VERVE PRO 8 SLIDING DOOR

CLICK FIT  
PRO

FINISHES:

SILVER

MATTE BLACK

BRUSHED BRASS



QUICK  
RELEASE  
DOUBLE  
WHEEL  
ROLLERS



SLIDING DOOR IN ALCOVE - SILVER

## VERVE PRO 8 – SLIDING DOOR

SIZE (mm)	ADJUSTMENT SIZE		ACCESS (mm)	CODE	CODE	CODE
	MIN (mm)	MAX (mm)		SILVER	BLACK	BRUSHED BRASS
1200	1150	1200	475	V8SA120SC	V8SA120BC	V8SA120BRBC
1400	1350	1400	575	V8SA140SC	V8SA140BC	V8SA140BRBC
1500	1450	1500	575	V8SA150SC	V8SA150BC	V8SA150BRBC

## VERVE PRO 8 – FRAMELESS SIDE PANELS

SIZE (mm)	ADJUSTMENT SIZE		CODE	CODE	CODE
	MIN (mm)	MAX (mm)	SILVER	BLACK	BRUSHED BRASS
700	670	695	V8SP70SC	V8SP70BC	V8SP70BRBC
760	730	755	V8SP76SC	V8SP76BC	V8SP76BRBC
800	770	795	V8SP80SC	V8SP80BC	V8SP80BRBC
900	870	895	V8SP90SC	V8SP90BC	V8SP90BRBC
1000	970	995	V8SP100SC	V8SP100BC	V8SP100BRBC

## VERVE PRO 8 – PROFILE EXTENSION

DESCRIPTION	CODE	CODE	CODE
	SILVER	BLACK	BRUSHED BRASS
30mm Compensating Wall Profile	V8CB30SC	V8CB30BC	V8CB30BRBC



DESIGNED FOR  
EVERYDAY LUXURY.

SLIDING DOOR WITH FRAMELESS  
SIDE PANEL - BRUSHED BRASS

# VERVE PRO 8 PIVOT DOOR

## FINISHES:

SILVER MATTE BLACK

BRUSHED BRASS



HANDLE DETAIL -  
MATTE BLACK



PIVOT DOOR WITH  
INLINE PANEL -  
MATTE BLACK

## VERVE PRO 8 – PIVOT DOOR

SIZE (mm)	ADJUSTMENT SIZE		ACCESS (mm)	CODE		CODE
	MIN (mm)	MAX (mm)		SILVER	BLACK	BRUSHED BRASS
700	650	700	417	V8PD70SC	V8PD70BC	V8PD70BRBC
800	750	800	517	V8PD80SC	V8PD80BC	V8PD80BRBC
900	850	900	617	V8PD90SC	V8PD90BC	V8PD90BRBC

## VERVE PRO 8 – FRAMELESS SIDE PANELS

SIZE (mm)	ADJUSTMENT SIZE		CODE		CODE
	MIN (mm)	MAX (mm)	SILVER	BLACK	BRUSHED BRASS
700	670	695	V8SP70SC	V8SP70BC	V8SP70BRBC
760	730	755	V8SP76SC	V8SP76BC	V8SP76BRBC
800	770	795	V8SP80SC	V8SP80BC	V8SP80BRBC
900	870	895	V8SP90SC	V8SP90BC	V8SP90BRBC
1000	970	995	V8SP100SC	V8SP100BC	V8SP100BRBC

## VERVE PRO 8 – INLINE PANELS

SIZE (mm)	CODE		CODE
	SILVER	BLACK	BRUSHED BRASS
300	V8IL30SC	V8IL30BC	V8IL30BRBC
400	V8IL40SC	V8IL40BC	V8IL40BRBC

## VERVE PRO 8 – PROFILE EXTENSION

DESCRIPTION	CODE		CODE
	SILVER	BLACK	BRUSHED BRASS
30mm Compensating Wall Profile	V8CB30SC	V8CB30BC	V8CB30BRBC



DESIGNED FOR  
EVERYDAY LUXURY.

PIVOT DOOR WITH FRAMELESS  
SIDE PANEL - SILVER

EXCEPTIONAL  
EVERYDAY.



## VERVE PRO

Verve PRO collection – a trusted favourite featuring durable 6mm glass, designed to deliver exceptional performance for everyday projects.

Engineered with the Verve Click Fit PRO assembly system, it ensures quick and hassle-free installation, making it the installers choice.

Available in timeless Silver and Matte Black, Verve PRO combines practicality with effortless style, making it a staple for every bathroom space.

Proven and dependable, Verve PRO is the perfect balance of quality and efficiency for trade professionals.

### FINISHES:

SILVER

MATTE BLACK

### KEY FEATURES:

<p><b>6mm</b></p> <p>TOUGHENED SAFETY GLASS</p>	<p><b>1900mm</b></p> <p>HEIGHT</p>	<p>UP TO <b>50mm</b></p> <p>PRODUCT ADJUSTMENT</p>	
<p>SOLID CHROME HANDLE DESIGN</p>	<p>POSITIVE MAGNETIC CLOSE ACTION</p>	<p>CLEARVUE GLASS COATING</p>	<p>QUICK RELEASE CHROME DOUBLE WHEEL ROLLERS</p>
<p>30mm WALL PROFILE EXTENSION AVAILABLE</p>	<p>CHROME PLATED COVER CAPS</p>	<p>REVERSIBLE FOR LEFT OR RIGHT HANDED INSTALLATION</p>	<p>20 YEAR GUARANTEE</p>

# VERVE PRO

## 1 DOOR QUADRANT & 1 DOOR OFFSET QUADRANT

**CLICK FIT  
PRO**

FINISHES:

SILVER

MATTE BLACK



1 DOOR QUADRANT -  
MATTE BLACK

QUICK RELEASE  
DOUBLE WHEEL ROLLERS



### VERVE PRO – 1 DOOR QUADRANT

SIZE (mm)	ADJUSTMENT SIZE		ACCESS (mm)	CODE	
	MIN (mm)	MAX (mm)		SILVER	BLACK
800	770	795	435	VOCQ80SC	VOCQ80BC
900	870	895	490	VOCQ90SC	VOCQ90BC
1000	970	995	490	VOCQ100SC	VOCQ100BC

### VERVE PRO – 1 DOOR OFFSET QUADRANT

SIZE (mm)	ADJUSTMENT SIZE		ACCESS (mm)	CODE	
	MIN (mm)	MAX (mm)		SILVER	BLACK
760 x 900	730-755	870-895	490	VOCQ76X90SC	VOCQ76X90BC
800 x 900	770-795	870-895	490	VOCQ80X90SC	-
800 x 1000	770-795	970-995	490	VOCQ80X100SC	VOCQ80X100BC
900 x 1000	870-895	970-995	490	VOCQ90X100SC	-
800 x 1200	770-795	1170-1195	490	VOCQ80X120SC	VOCQ80X120BC
900 x 1200	870-895	1170-1195	490	VOCQ90X120SC	VOCQ90X120BC

\*All Flair Quadrant and Offset Quadrant trays have a 550mm radius.



EXCEPTIONAL  
EVERYDAY.

1 DOOR OFFSET QUADRANT - SILVER

# VERVE PRO

## 2 DOOR QUADRANT & 2 DOOR OFFSET QUADRANT

**CLICK FIT**  
**PRO**

FINISHES:

SILVER



SOLID CHROME PLATED HANDLES

2 DOOR OFFSET QUADRANT - SILVER

### VERVE PRO – 2 DOOR QUADRANT

SIZE (mm)	ADJUSTMENT SIZE MIN (mm)	ADJUSTMENT SIZE MAX (mm)	ACCESS (mm)	CODE SILVER
800	770	795	385	VCQ80SC
900	870	895	538	VCQ90SC

### VERVE PRO – 2 DOOR OFFSET QUADRANT

SIZE (mm)	ADJUSTMENT SIZE MIN (mm)	ADJUSTMENT SIZE MAX (mm)	ACCESS (mm)	CODE SILVER
800 x 1000	770-795	970-995	468	VCQ80X100SC
800 x 1100	770-795	1070-1095	468	VCQ80X110SC
800 x 1200	770-795	1170-1195	468	VCQ80X120SC
900 x 1100	870-895	1070-1095	538	VCQ90X110SC
900 x 1200	870-895	1170-1195	538	VCQ90X120SC

\*All Flair Quadrant and Offset Quadrant trays have a 550mm radius.

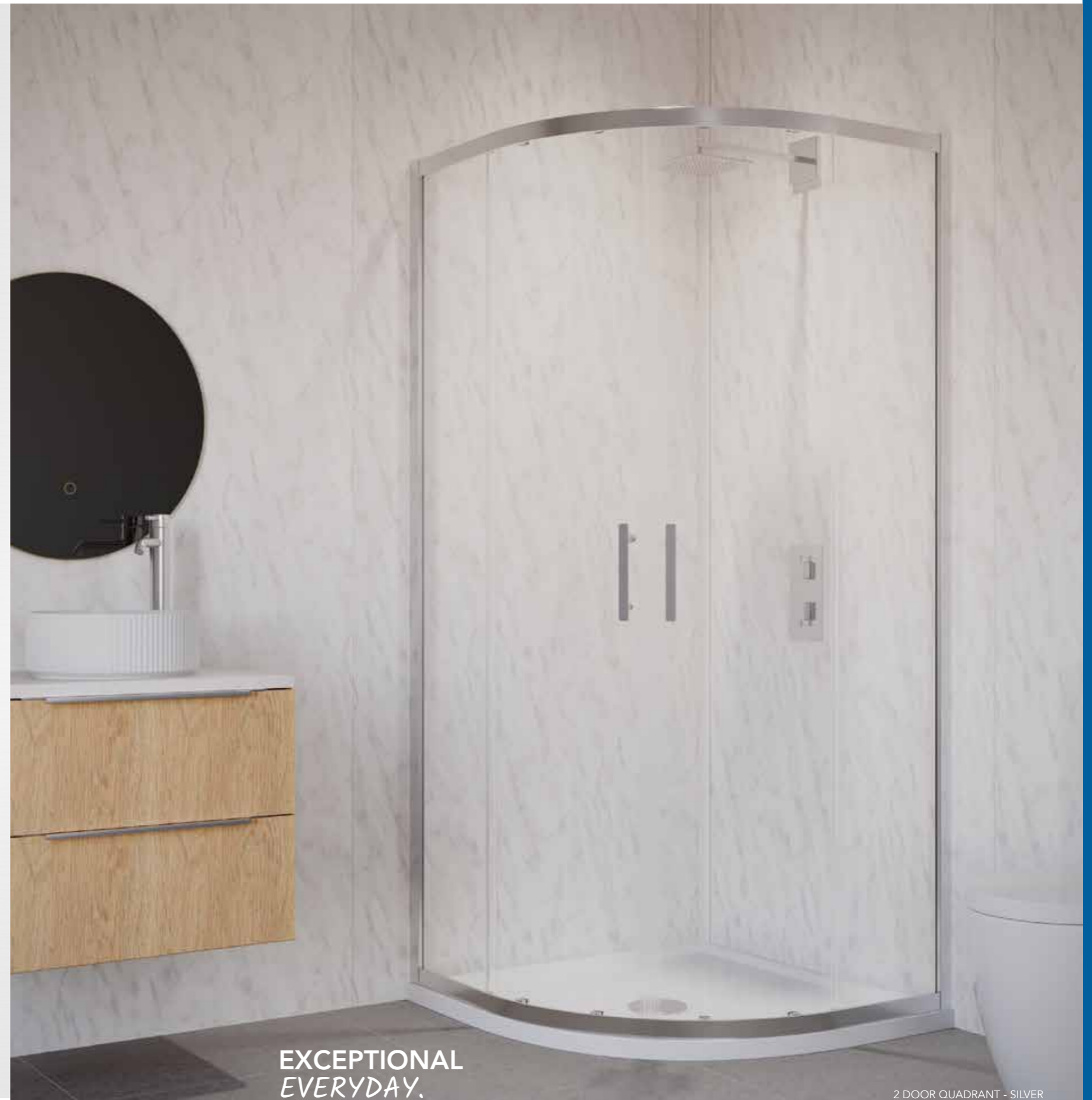

EXCEPTIONAL  
EVERYDAY.

2 DOOR QUADRANT - SILVER

# VERVE PRO SLIDING DOOR

**CLICK FIT  
PRO**

FINISHES:

SILVER

**MATTE BLACK**



## VERVE PRO - SLIDING DOOR

SIZE (mm)	ADJUSTMENT SIZE		ACCESS (mm)	CODE	CODE
	MIN (mm)	MAX (mm)		SILVER	BLACK
1000	950	1000	375	VSA100SC	VSA100BC
1100	1050	1100	425	VSA110SC	VSA110BC
1200	1150	1200	475	VSA120SC	VSA120BC
1300	1250	1300	525	VSA130SC	VSA130BC
1400	1350	1400	575	VSA140SC	VSA140BC
1500	1450	1500	575	VSA150SC	VSA150BC
1600	1550	1600	575	VSA160SC	VSA160BC
1700	1650	1700	575	VSA170SC	VSA170BC
1800	1750	1800	575	VSA180SC	—

## VERVE PRO - SEMI FRAMED SIDE PANELS

SIZE (mm)	ADJUSTMENT SIZE		CODE	CODE
	MIN (mm)	MAX (mm)	SILVER	BLACK
700	670	695	VSP70SC	VSP70BC
760	730	755	VSP76SC	VSP76BC
800	770	795	VSP80SC	VSP80BC
900	870	895	VSP90SC	VSP90BC
1000	970	995	VSP100SC	VSP100BC

30mm compensating wall profile included with every Verve Side Panel  
Please note, when using a side panel, the maximum door adjustment is reduced by 25mm.

## VERVE PRO - PROFILE EXTENSION

DESCRIPTION	CODE	CODE
	SILVER	BLACK
30mm Compensating Wall Profile	VCB30SC	VCB30BC

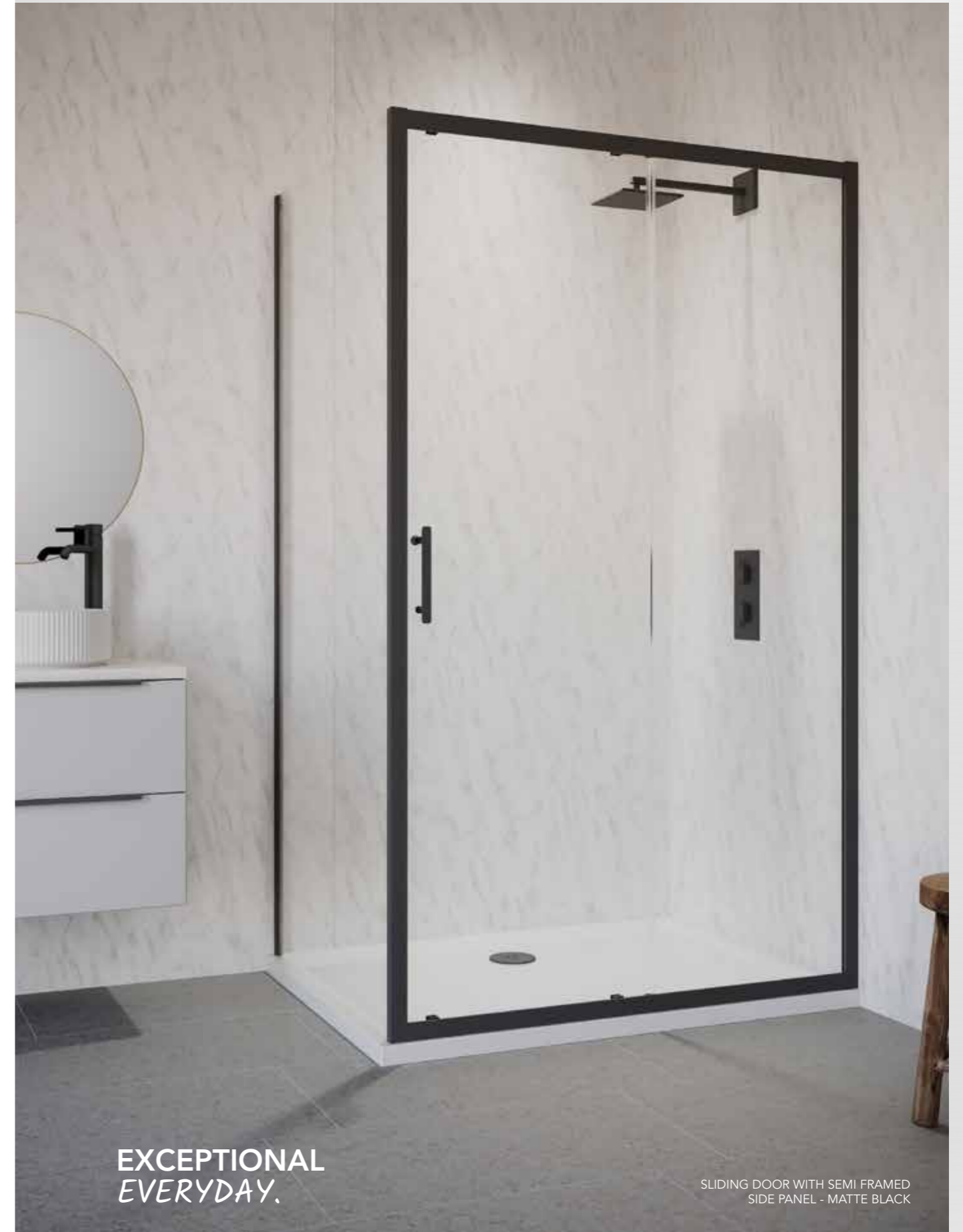

# VERVE PRO

## LEVEL ACCESS SLIDING DOOR

**CLICK FIT**  
**PRO**

FINISHES:

SILVER

### VERVE PRO - LEVEL ACCESS SLIDING DOOR

SIZE (mm)	ADJUSTMENT SIZE MIN (mm) MAX (mm)	ACCESS (mm)	CODE SILVER
1000 - Left Hand	950 1000	380	VSASS100LSC
1000 - Right Hand	950 1000	380	VSASS100RSC
1100 - Right Hand	1050 1100	430	VSASS110RSC
1200 - Left Hand	1150 1200	480	VSASS120LSC
1200 - Right Hand	1150 1200	480	VSASS120RSC
1300 - Left Hand	1250 1300	530	VSASS130LSC
1300 - Right Hand	1250 1300	530	VSASS130RSC
1400 - Left Hand	1350 1400	580	VSASS140LSC
1400 - Right Hand	1350 1400	580	VSASS140RSC
1500 - Left Hand	1450 1500	580	VSASS150LSC
1500 - Right Hand	1450 1500	580	VSASS150RSC
1600 - Left Hand	1550 1600	580	VSASS160LSC
1600 - Right Hand	1550 1600	580	VSASS160RSC
1700 - Left Hand	1650 1700	580	VSASS170LSC
1700 - Right Hand	1650 1700	580	VSASS170RSC
1800 - Left Hand	1750 1800	580	VSASS180LSC
1800 - Right Hand	1750 1800	580	VSASS180RSC

### VERVE PRO - SEMI FRAMED SIDE PANELS

SIZE (mm)	ADJUSTMENT SIZE MIN (mm) MAX (mm)	CODE SILVER
700	670 695	VSP70SC
760	730 755	VSP76SC
800	770 795	VSP80SC
900	870 895	VSP90SC
1000	970 995	VSP100SC

30mm Compensating Wall Profile included with every Verve Side Panel  
Please note, when using a side panel, the maximum door adjustment is reduced by 25mm.

### VERVE PRO - PROFILE EXTENSION

DESCRIPTION	CODE SILVER
30mm Compensating Wall Profile	VCB30SC



LEVEL ACCESS SLIDING DOOR (LEFT HAND) IN ALCOVE

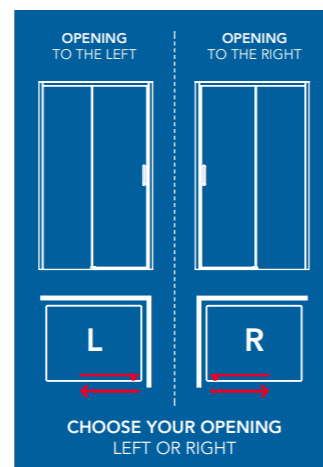

VSASS FEATURES AN ANTI-JUMP MECHANISM ENSURING DOOR REMAINS SECURELY ON THE TRACKS

**ANTI-JUMP MECHANISM**



EXCEPTIONAL  
EVERYDAY.

LEVEL ACCESS SLIDING DOOR (RIGHT HAND) WITH SIDE PANEL

# VERVE PRO TRIPLE PANEL SLIDING DOOR

FINISHES:

SILVER



TRIPLE PANEL SLIDING DOOR IN ALCOVE

## VERVE PRO - TRIPLE PANEL SLIDING DOOR

SIZE (mm)	ADJUSTMENT SIZE		ACCESS (mm)	CODE
	MIN (mm)	MAX (mm)		
900	850	900	430	V3SA90SC
1000	950	1000	497	V3SA100SC
1100	1050	1100	563	V3SA110SC
1200	1150	1200	630	V3SA120SC

## VERVE PRO - SEMI FRAMED SIDE PANELS

SIZE (mm)	ADJUSTMENT SIZE		CODE
	MIN (mm)	MAX (mm)	
700	670	695	VSP70SC
760	730	755	VSP76SC
800	770	795	VSP80SC
900	870	895	VSP90SC
1000	970	995	VSP100SC

30mm compensating wall profile included with every Verve Side Panel  
Please note, when using a side panel, the maximum door adjustment is reduced by 25mm.

## VERVE PRO - PROFILE EXTENSION

DESCRIPTION	CODE
30mm Compensating Wall Profile	VCB30SC

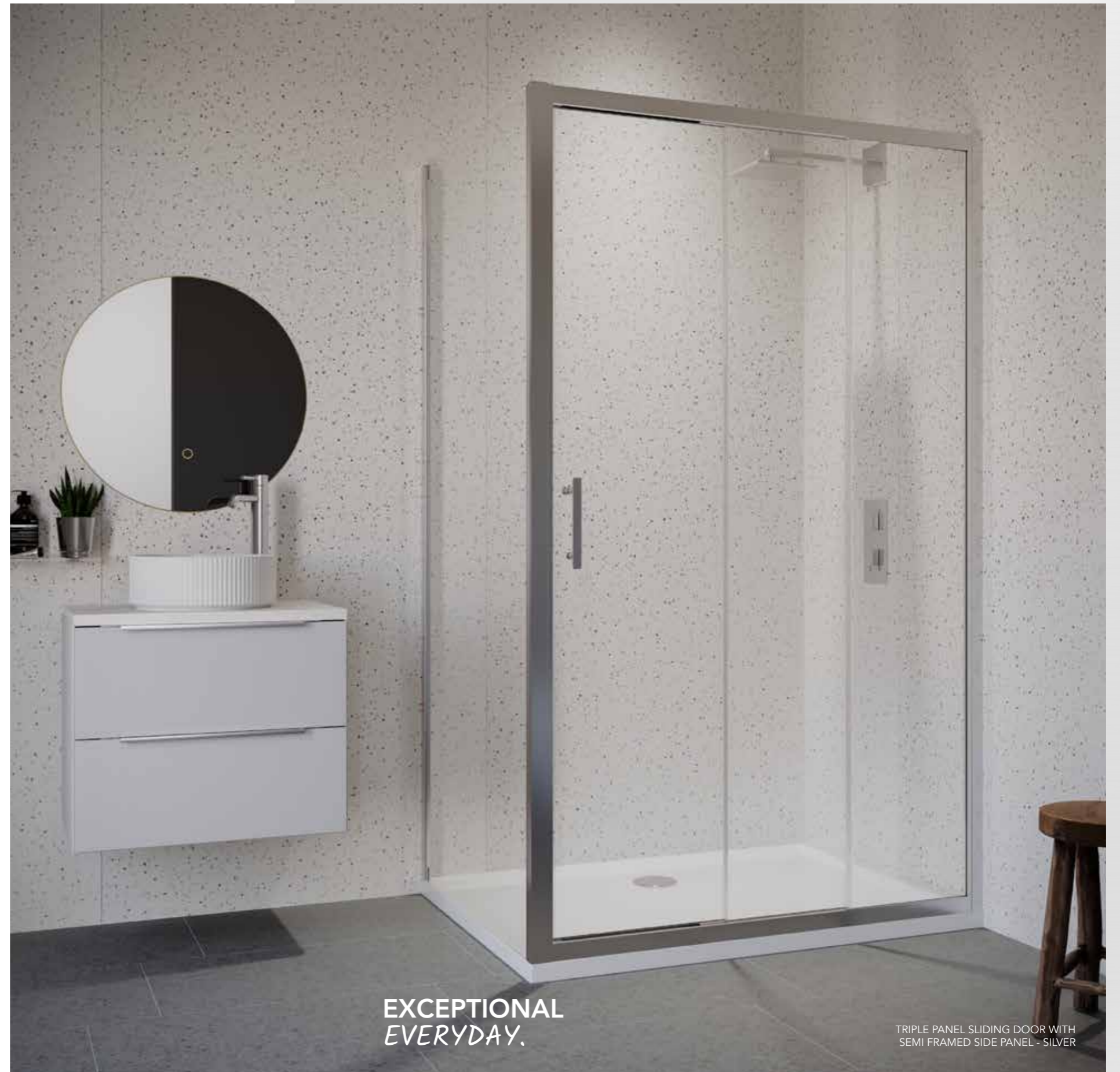

EXCEPTIONAL  
EVERYDAY.

TRIPLE PANEL SLIDING DOOR WITH SEMI FRAMED SIDE PANEL - SILVER

# VERVE PRO BIFOLD DOOR

## FINISHES:

SILVER MATTE BLACK



BIFOLD DOOR WITH SEMI FRAMED SIDE PANEL - SILVER

### VERVE PRO - BIFOLD DOOR

SIZE (mm)	ADJUSTMENT SIZE		ACCESS (mm)	CODE	CODE
	MIN (mm)	MAX (mm)		SILVER	BLACK
700	650	700	413	VBF70SC	VBF70BC
760	710	760	473	VBF76SC	-
800	750	800	513	VBF80SC	VBF80BC
900	850	900	613	VBF90SC	VBF90BC
1000	950	1000	713	VBF100SC	VBF100BC

### VERVE PRO - SEMI FRAMED SIDE PANELS

SIZE (mm)	ADJUSTMENT SIZE		CODE	CODE
	MIN (mm)	MAX (mm)	SILVER	BLACK
700	670	695	VSP70SC	VSP70BC
760	730	755	VSP76SC	VSP76BC
800	770	795	VSP80SC	VSP80BC
900	870	895	VSP90SC	VSP90BC
1000	970	995	VSP100SC	VSP100BC

30mm compensating wall profile included with every Verve Side Panel  
Please note, when using a side panel, the maximum door adjustment is reduced by 25mm.

### VERVE PRO - INLINE PANELS

SIZE (mm)	CODE	CODE
	SILVER	BLACK
200	VIL20SC	VIL20BC
300	VIL30SC	VIL30BC
400	VIL40SC	VIL40BC
500	VIL50SC	VIL50BC

### VERVE PRO - PROFILE EXTENSION

DESCRIPTION	CODE	CODE
	SILVER	BLACK
30mm Compensating Wall Profile	VCB30SC	VCB30BC



EXCEPTIONAL  
EVERYDAY.

BIFOLD DOOR IN ALCOVE - MATTE BLACK

# VERVE PRO CORNER ENTRY

CLICK FIT  
PRO

FINISHES:

SILVER

MATTE BLACK



QUICK RELEASE  
DOUBLE WHEEL  
ROLLERS



CORNER ENTRY -  
SILVER

## VERVE PRO - CORNER ENTRY

SIZE (mm)	ADJUSTMENT SIZE		ACCESS (mm)	CODE	CODE
	MIN (mm)	MAX (mm)		SILVER	BLACK
700	670	695	340	VCE70SSC	—
760	730	755	382	VCE76SSC	—
800	770	795	410	VCE80SSC	VCE80SBC
900	870	895	485	VCE90SSC	VCE90SBC
1000	970	995	551	VCE100SSC	—
1200	1170	1195	551	VCE120SSC	—



EXCEPTIONAL  
EVERYDAY.

CORNER ENTRY - MATTE BLACK

# VERVE PRO PIVOT DOOR

## FINISHES:

SILVER MATTE BLACK



PIVOT DOOR WITH INLINE PANEL - SILVER

### VERVE PRO - PIVOT DOOR

SIZE (mm)	ADJUSTMENT SIZE		ACCESS (mm)	CODE	CODE
	MIN (mm)	MAX (mm)		SILVER	BLACK
700	650	700	417	VPD70SC	-
760	710	760	477	VPD76SC	-
800	750	800	517	VPD80SC	VPD80BC
900	850	900	617	VPD90SC	VPD90BC
1000	950	1000	717	VPD100SC	VPD100BC

### VERVE PRO - SEMI FRAMED SIDE PANELS

SIZE (mm)	ADJUSTMENT SIZE		CODE	CODE
	MIN (mm)	MAX (mm)	SILVER	BLACK
700	670	695	VSP70SC	VSP70BC
760	730	755	VSP76SC	VSP76BC
800	770	795	VSP80SC	VSP80BC
900	870	895	VSP90SC	VSP90BC
1000	970	995	VSP100SC	VSP100BC

30mm compensating wall profile included with every Verve Side Panel  
Please note, when using a side panel, the maximum door adjustment is reduced by 25mm.

### VERVE PRO - INLINE PANELS

SIZE (mm)	CODE	CODE
	SILVER	BLACK
200	VIL20SC	VIL20BC
300	VIL30SC	VIL30BC
400	VIL40SC	VIL40BC
500	VIL50SC	VIL50BC

### VERVE PRO - PROFILE EXTENSION

DESCRIPTION	CODE	CODE
	SILVER	BLACK
30mm Compensating Wall Profile	VCB30SC	VCB30BC



EXCEPTIONAL  
EVERYDAY.

PIVOT DOOR WITH SEMI FRAMED  
SIDE PANEL - MATTE BLACK



# VERVE PRO WETROOMS

Choose a Verve PRO wetroom for a luxurious walk-in shower experience. These versatile screens are suitable for shower tray or wetroom floor application.

Verve PRO wetroom panels are constructed from 8mm toughened safety glass and offer superb quality.

## FINISHES:



# VERVE PRO WETROOM SCREENS

## FINISHES:

SILVER MATTE BLACK

BRUSHED BRASS

## KEY FEATURES

**8mm**  
TOUGHENED  
SAFETY GLASS

**2000mm**  
HEIGHT

CLEARVUE  
GLASS  
COATING

UP TO  
**15mm**  
PRODUCT  
ADJUSTMENT

STABILISING BAR  
INCLUDED

SUITABLE FOR  
SHOWER TRAY OR  
WETROOM FLOOR  
APPLICATION



WETROOM WITH T-PIECE  
STABILISING BAR - MATTE BLACK

## VERVE PRO - WETROOMS

SIZE (mm)	ADJUSTMENT SIZE		CODE	CODE	CODE
	MIN (mm)	MAX (mm)	SILVER	BLACK	BRUSHED BRASS
600	575	590	RWR60SCV	RWR60BCV	RWR60BRBCV
700	675	690	RWR70SCV	RWR70BCV	RWR70BRBCV
800	775	790	RWR80SCV	RWR80BCV	RWR80BRBCV
900	875	890	RWR90SCV	RWR90BCV	RWR90BRBCV
1000	975	990	RWR100SCV	RWR100BCV	RWR100BRBCV
1100	1075	1090	RWR110SCV	RWR110BCV	RWR110BRBCV
1200	1175	1190	RWR120SCV	RWR120BCV	RWR120BRBCV
1400	1375	1390	RWR140SCV	RWR140BCV	RWR140BRBCV

## VERVE PRO - ROTATING WETROOM PANELS

SIZE (mm)	ADJUSTMENT SIZE		CODE	CODE	CODE
	MIN (mm)	MAX (mm)	SILVER	BLACK	BRUSHED BRASS
300	675	690	RRP30SCV	RRP30BCV	RRP30BRBCV
400	775	790	RRP40SCV	RRP40BCV	RRP40BRBCV

Please Note - Rotating wetroom panel sold separately.

## VERVE PRO - T-PIECE STABILISING BAR

DESCRIPTION	CODE	CODE	CODE
	SILVER	BLACK	BRUSHED BRASS
T-Piece	S-RWRTSV	S-RWRTBLKV	S-RWRTBRBV

Purchased separately if fitted with a Verve Wetroom End Panel.



EXCEPTIONAL  
EVERYDAY.

WETROOM WITH T-PIECE STABILISING BAR - BRUSHED BRASS



# VERVE PRO BATHSCREENS

Featuring a versatile collection of 8mm and 6mm bathscreens, Verve PRO bathscreens are each crafted to deliver exceptional durability and performance, our collection offers multiple styles to suit modern and classic spaces - something for every design preference.

## FINISHES:

- SILVER
- BRUSHED NICKEL
- BRUSHED BRASS
- MATTE BLACK

**8mm**  
TOUGHENED  
SAFETY GLASS

**6mm**  
TOUGHENED  
SAFETY GLASS

UP TO  
**1500mm**  
HEIGHT

# VERVE PRO

## 8MM BATHSCREENS

FINISHES:

SILVER

MATTE BLACK

BRUSHED BRASS

BRUSHED NICKEL



8MM 2 PANEL BATHSCREEN (1 FIXED PANEL / 1 ROTATING PANEL - SQUARE EDGE) - MATTE BLACK



8MM 2 PANEL BATHSCREEN (1 FIXED PANEL / 1 ROTATING PANEL - SQUARE EDGE) - BRUSHED BRASS

### VERVE PRO - 8MM BATHSCREENS

DESCRIPTION	HEIGHT MIN (mm)	WIDTH MAX (mm)	COLOUR	CODE
8mm 2 Panel Bathscreen - 1 Fixed Panel / Rotating Panel - Square Edge	1500	900	Silver	VBSI3SC
8mm 2 Panel Bathscreen - 1 Fixed Panel / Rotating Panel - Square Edge	1500	900	Matte Black	VBSI3BC
8mm 2 Panel Bathscreen - 1 Fixed Panel / Rotating Panel - Square Edge	1500	900	Brushed Brass	VBSI3BRBC
8mm 2 Panel Bathscreen - 1 Fixed Panel / Rotating Panel - Square Edge	1500	900	Brushed Nickel	VBSI3BRNC

KEY  
FEATURES

8mm

TOUGHENED  
SAFETY GLASS

1500mm

HEIGHT

CLEARVUE  
GLASS  
COATING

INWARD  
ROTATING PANEL  
UP TO 180°

UNIVERSAL  
FOR LEFT OR  
RIGHT HANDED  
OPENING

20 YEAR  
GUARANTEE

IMPORTANT NOTE:

- These Bathscreens are a water deflector and splash proof only.
- It is advised that all Bathscreens are fitted to the inside edge of the bath to ensure maximum effectiveness.

### NEW BRUSHED NICKEL FINISH

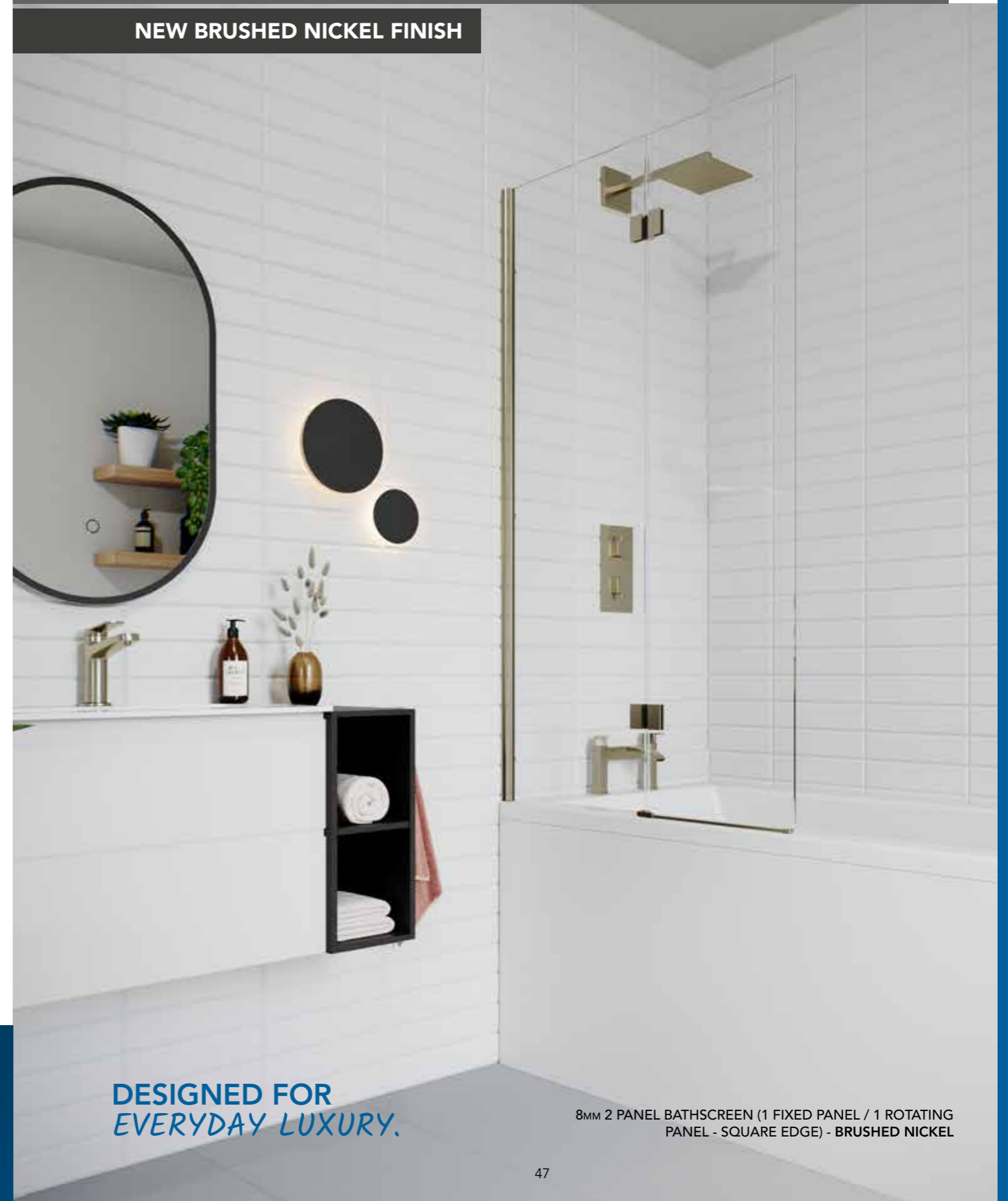

DESIGNED FOR  
EVERYDAY LUXURY.

8MM 2 PANEL BATHSCREEN (1 FIXED PANEL / 1 ROTATING PANEL - SQUARE EDGE) - BRUSHED NICKEL

# VERVE PRO

## 6MM CURVED BATHSCREENS

FINISHES:

SILVER

**MATTE BLACK**

BRUSHED BRASS

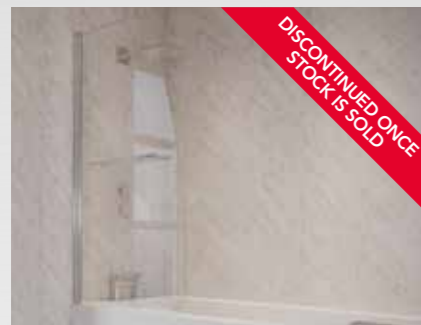

DISCONTINUED ONCE STOCK IS SOLD

6MM SAIL BATHSCREEN WITH TOWEL RAIL - VBS12SC



6MM 1 FIXED & 1 ROTATING PANEL CURVED EDGE - VBS75C



DISCONTINUED ONCE STOCK IS SOLD

6MM ROTATING BATHSCREEN CURVED EDGE WITH TOWEL RAIL - VBS35C

### VERVE PRO - CURVED BATHSCREENS

DESCRIPTION	HEIGHT MIN (mm)	WIDTH MAX (mm)	COLOUR	CODE
6mm Rotating Bathscreen - Curved Edge	1400	800	Silver	VBS1SC
6mm Rotating Bathscreen - Curved Edge	1400	800	Matte Black	VBS1BC
6mm Rotating Bathscreen - Curved Edge	1400	800	Brushed Brass	VBS1BRBC
6mm Rotating Bathscreen - Curved Edge with Towel Rail	1500	800	Silver	VBS35C
6mm 1 Fixed & 1 Rotating Panel - Curved Edge	1500	900	Silver	VBS75C
6mm Sail Bathscreen with Towel Rail	1500	800	Silver	VBS12SC
6mm 2 Panel Rotating Bathscreen - Curved Edge	1500	900	Silver	VBS55C

#### IMPORTANT NOTE:

- These Bathscreens are a water deflector and splash proof only.
- It is advised that all Bathscreens are fitted to the inside edge of the bath to ensure maximum effectiveness.



EXCEPTIONAL EVERYDAY.

6MM ROTATING BATHSCREEN CURVED EDGE - MATTE BLACK

#### KEY FEATURES

6E

TOUGHENED SAFETY GLASS

UP TO 1500mm HEIGHT

CLEARVUE GLASS COATING

UP TO 15mm PRODUCT ADJUSTMENT

REVERSIBLE FOR LEFT OR RIGHT HANDED INSTALLATION

20 YEAR GUARANTEE

# VERVE PRO

## 6MM SQUARE BATHSCREENS

### FINISHES:

SILVER

BRUSHED BRASS



6MM 2 PANEL BATHSCREEN - 1 FIXED & 1 ROTATING PANEL - VBS8SC



6MM FIXED BATHSCREEN DEFLECTOR 300MM - VBSG30SC



6MM FIXED BATHSCREEN WITH CHROME ANGLED SUPPORT BAR - VBS10SC

### VERVE PRO - SQUARE BATHSCREENS

DESCRIPTION	HEIGHT MIN (mm)	WIDTH MAX (mm)	COLOUR	CODE
6mm 2 Panel Bathscreen - 1 Fixed & 1 Rotating Panel	1500	900	Silver	VBS8SC
6mm Rotating Bathscreen - Square Edge	1400	800	Silver	VBS2SC
6mm Rotating Bathscreen - Square Edge	1400	800	Brushed Brass	VBS2BRBC
6mm Fixed Bathscreen with Chrome Angled Support Bar	1400	850	Silver	VBS10SC
6mm 2 Panel Bathscreen - Both Panels Rotating	1500	900	Silver	VBS6SC
6mm Fixed Bathscreen Deflector 300mm	1430	300	Silver	VBSG30SC

### IMPORTANT NOTE:

- These Bathscreens are a water deflector and splash proof only.
- It is advised that all Bathscreens are fitted to the inside edge of the bath to ensure maximum effectiveness.

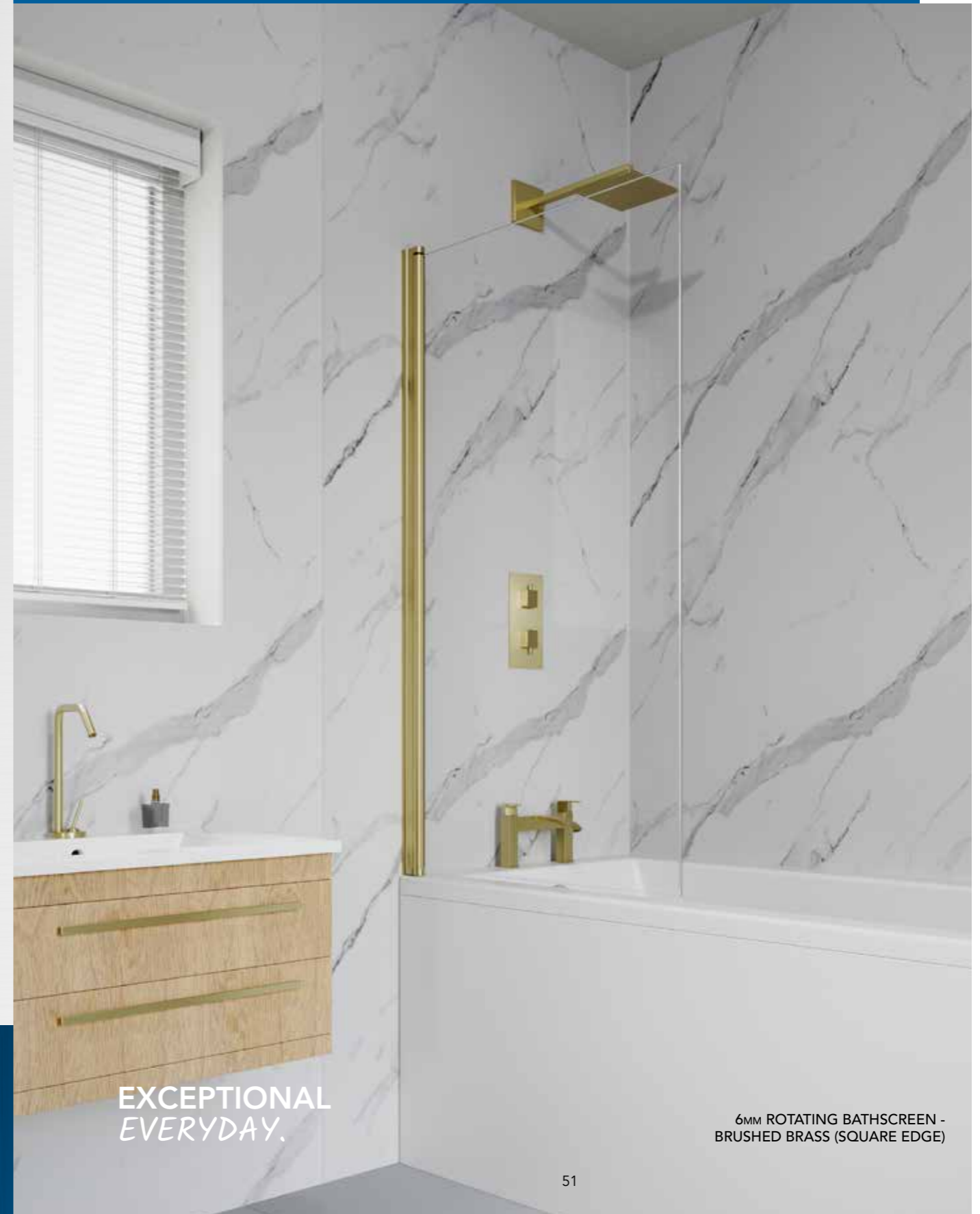

EXCEPTIONAL  
EVERYDAY.

6MM ROTATING BATHSCREEN - BRUSHED BRASS (SQUARE EDGE)

### KEY FEATURES



# HYDRO EXPRESS

## 4 & 5 PANEL BATHSCREENS

**IMPORTANT NOTE:**

- These Bathscreens are a water deflector and splash proof only.
- It is advised that all Bathscreens are fitted to the inside edge of the bath to ensure maximum effectiveness.



4 PANEL BATH SCREEN



5 PANEL BATHSCREEN

**HYDRO - BATHSCREENS**

DESCRIPTION	HEIGHT	WIDTH	COLOUR	CODE
4 Panel Bathscreen	1400mm	850mm	Silver	PBSG4SC
5 Panel Bathscreen	1400mm	1050mm	Silver	PBSG5SC

## BATH PANELS

High gloss acrylic white bath panels.



**BATH PANELS**

DESCRIPTION	HEIGHT	WIDTH	COLOUR	CODE
Front Bath Panel	533mm	1700mm	White	BP5FWH
End Bath Panel	533mm	711mm	White	BP5EWH

EXCEPTIONAL  
EVERYDAY.



# HYDRO EXPRESS

Hydro Express is an exciting remodel of Hydro - a tried and trusted brand brought to you by Flair Showers. Hydro's new design is crisp and contemporary with sleek modern handles and minimalist silver profiles.

Each door is 1850mm high and features up to 6mm toughened safety glass with a ClearVue glass coating. Chrome quick release rollers ensure easy cleaning while magnetic seals provide a watertight close.

This innovative range also boasts an Express Fit mechanism with chrome fixed panel clips that is a firm favourite with Installers.

Hydro Express - designed to suit your space and budget.

## FINISHES:

SILVER

## KEY FEATURES:

<p>UP TO <b>6mm</b> TOUGHENED SAFETY GLASS</p>	<p><b>1850mm</b> HEIGHT</p>	<p>UP TO <b>50mm</b> PRODUCT ADJUSTMENT</p>		
<p>CHROME PLATED ABS HANDLES</p>	<p>POSITIVE MAGNETIC CLOSE ACTION</p>	<p>CHROME FIXED PANEL CLIP</p>	<p>QUICK RELEASE CHROME SINGLE WHEEL ROLLER</p>	
<p>TOP CAPS / COVER CAPS</p>	<p>30mm WALL PROFILE EXTENSION AVAILABLE</p>	<p>REVERSIBLE FOR LEFT OR RIGHT HANDED INSTALLATION</p>	<p>CLEARVUE GLASS COATING</p>	<p>10 YEAR GUARANTEE</p>

# HYDRO EXPRESS

## 2 DOOR QUADRANT & OFFSET QUADRANT

FINISHES:

SILVER



2 DOOR OFFSET QUADRANT



HYDRO - BOTTOM WHEEL ROLLER

### HYDRO EXPRESS - 2 DOOR QUADRANT

DESCRIPTION	ADJUSTMENT SIZE		ACCESS	CODE - SILVER
	MIN	MAX		
800mm	770mm	795mm	395mm	HYCQ80SC
900mm	870mm	895mm	545mm	HYCQ90SC

### HYDRO EXPRESS - OFFSET QUADRANT

DESCRIPTION	ADJUSTMENT SIZE		ACCESS	CODE - SILVER
	MIN	MAX		
800 x 1000mm	770-795mm	970-995mm	475mm	HYCQ80X100SC
800 x 1200mm	770-795mm	1170-1195mm	475mm	HYCQ80X120SC
900 x 1200mm	870-895mm	1170-1195mm	545mm	HYCQ90X120SC

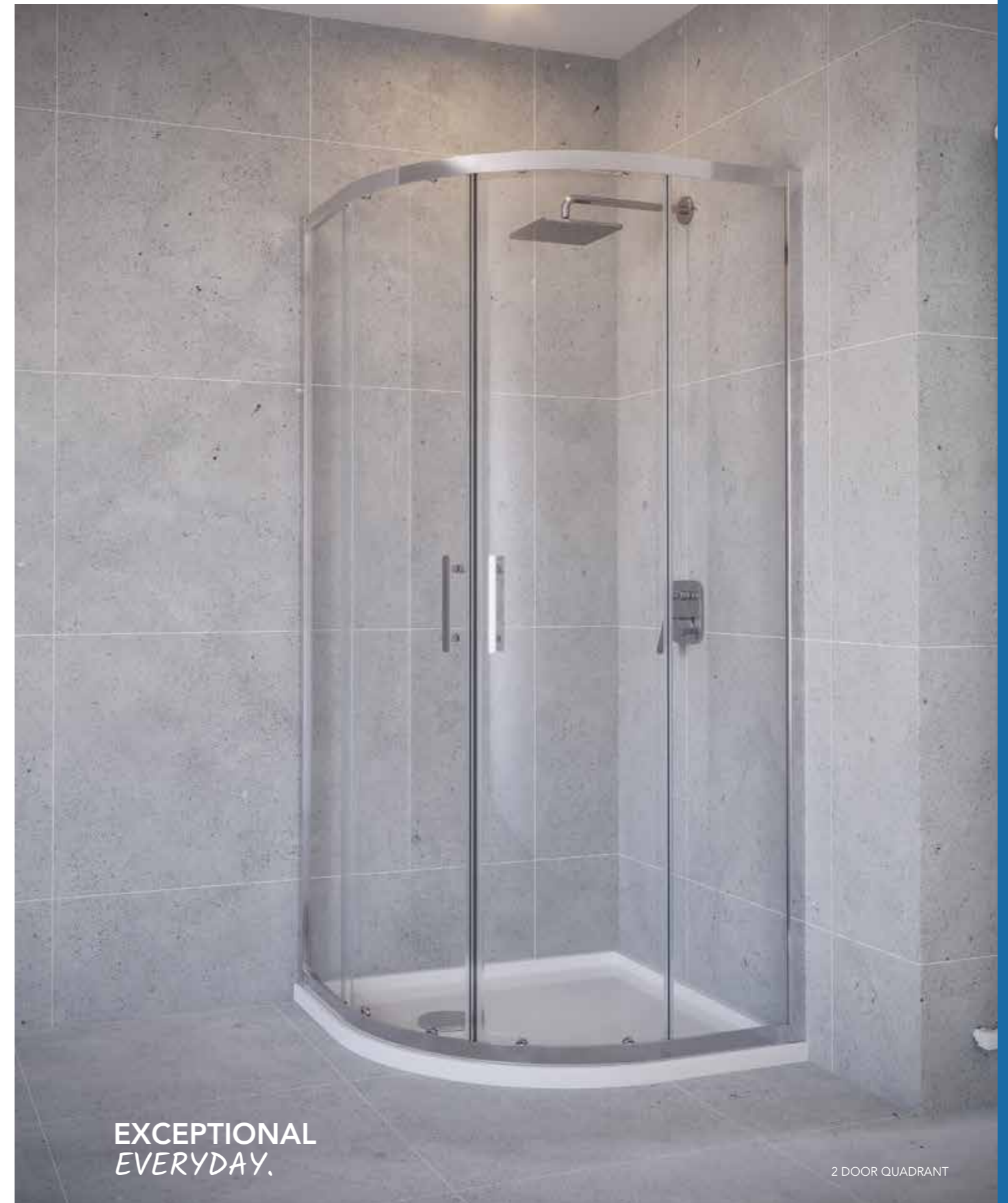

EXCEPTIONAL  
EVERYDAY.

2 DOOR QUADRANT

# HYDRO EXPRESS SLIDING DOOR

FINISHES:

SILVER



SLIDING DOOR  
WITH SIDE PANEL

HYDRO - BOTTOM  
WHEEL ROLLER



## HYDRO EXPRESS - SLIDING DOOR

DESCRIPTION	ADJUSTMENT SIZE		ACCESS	CODE - SILVER
	MIN	MAX		
1000mm	950mm	1000mm	376mm	HYSA100SC
1100mm	1050mm	1100mm	426mm	HYSA110SC
1200mm	1150mm	1200mm	476mm	HYSA120SC

## HYDRO EXPRESS - SEMI FRAMED SIDE PANELS

DESCRIPTION	ADJUSTMENT SIZE		CODE - SILVER
	MIN	MAX	
700mm	670mm	695mm	HYSP70SC
760mm	730mm	755mm	HYSP76SC
800mm	770mm	795mm	HYSP80SC
900mm	870mm	895mm	HYSP90SC
1000mm	970mm	995mm	HYSP100SC

Please note, when using a side panel, the maximum door adjustment is reduced by 25mm.

## HYDRO EXPRESS - PROFILE EXTENSION

DESCRIPTION	CODE - SILVER
30mm Compensating Wall Profile	HYCB30SC



EXCEPTIONAL  
EVERYDAY.

SLIDING DOOR  
IN ALCOVE

# HYDRO EXPRESS CORNER ENTRY

FINISHES:

SILVER



CONTEMPORARY  
HANDLE DESIGN

HYDRO - BOTTOM  
WHEEL ROLLER



## HYDRO EXPRESS - CORNER ENTRY

DESCRIPTION	ADJUSTMENT SIZE		ACCESS	CODE - SILVER
	MIN	MAX		
760mm	730mm	755mm	387mm	HYCE76SC
800mm	770mm	795mm	415mm	HYCE80SC
900mm	870mm	895mm	486mm	HYCE90SC



EXCEPTIONAL  
EVERYDAY.

CORNER  
ENTRY

# HYDRO EXPRESS BIFOLD DOOR

FINISHES:

SILVER



TOP CAPS / COVER CAPS

BIFOLD DOOR WITH SIDE PANEL

## HYDRO EXPRESS - BIFOLD DOOR

DESCRIPTION	ADJUSTMENT SIZE		ACCESS	CODE - SILVER
	MIN	MAX		
700mm	650mm	700mm	415mm	HYBF70SC
760mm	710mm	760mm	475mm	HYBF76SC
800mm	750mm	800mm	515mm	HYBF80SC
900mm	850mm	900mm	615mm	HYBF90SC
1000mm	950mm	1000mm	715mm	HYBF100SC

## HYDRO EXPRESS - SEMI FRAMED SIDE PANELS

DESCRIPTION	ADJUSTMENT SIZE		CODE - SILVER
	MIN	MAX	
700mm	670mm	695mm	HYSP70SC
760mm	730mm	755mm	HYSP76SC
800mm	770mm	795mm	HYSP80SC
900mm	870mm	895mm	HYSP90SC
1000mm	970mm	995mm	HYSP100SC

Please note, when using a side panel, the maximum door adjustment is reduced by 25mm.

## HYDRO EXPRESS - PROFILE EXTENSION

DESCRIPTION	CODE - SILVER
30mm Compensating Wall Profile	HYCB30SC

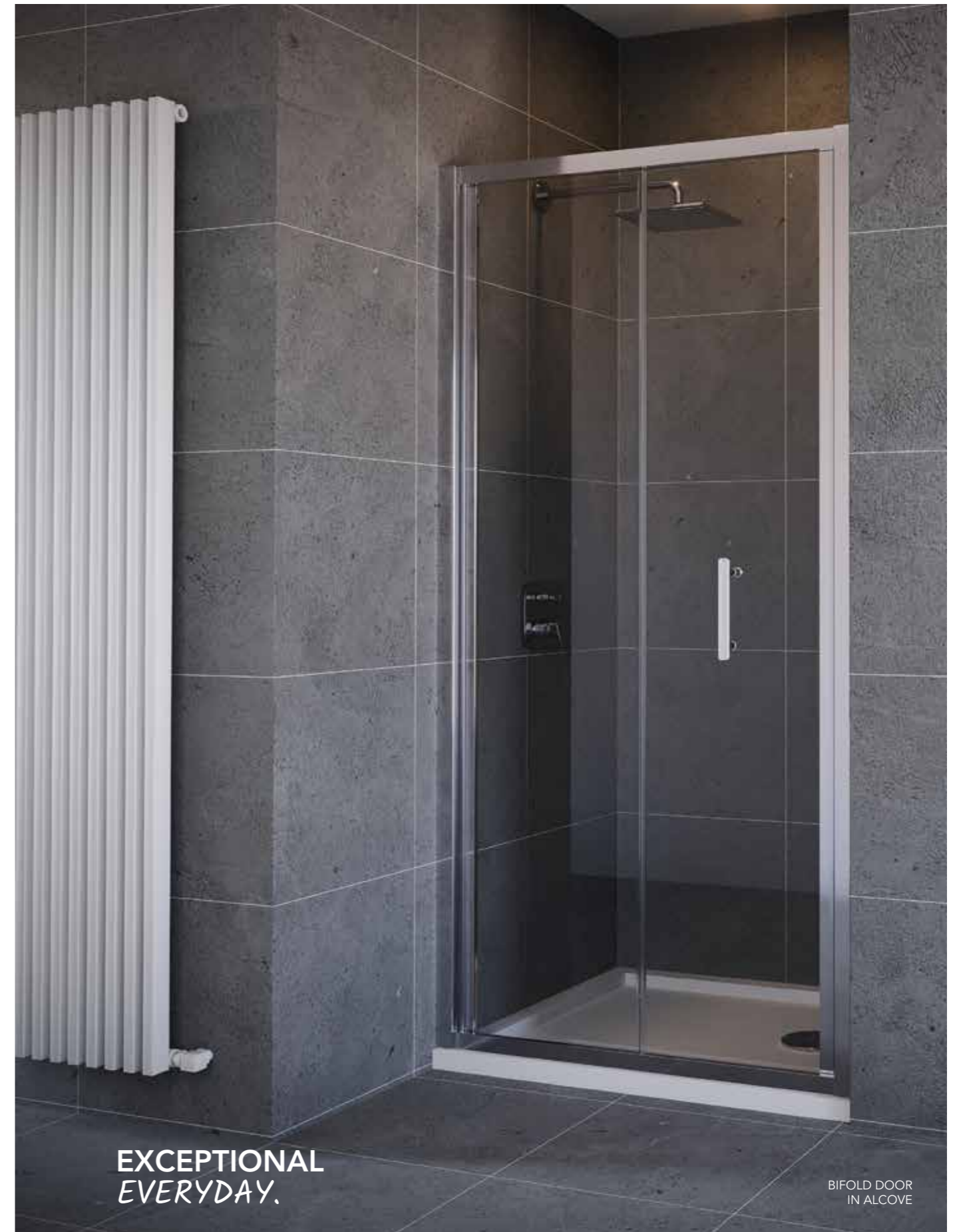

EXCEPTIONAL  
EVERYDAY.

BIFOLD DOOR IN ALCOVE

# HYDRO EXPRESS PIVOT DOOR

FINISHES:

SILVER



QUALITY  
PIVOT  
HINGE  
DESIGN

PIVOT DOOR  
IN ALCOVE

## HYDRO EXPRESS - PIVOT DOOR

DESCRIPTION	ADJUSTMENT SIZE		CODE - SILVER
	MIN	MAX	
700mm	650mm	700mm	HYPD70SC
760mm	710mm	760mm	HYPD76SC
800mm	750mm	800mm	HYPD80SC
900mm	850mm	900mm	HYPD90SC

## HYDRO EXPRESS - SEMI FRAMED SIDE PANELS

DESCRIPTION	ADJUSTMENT SIZE		CODE - SILVER
	MIN	MAX	
700mm	670mm	695mm	HYSP70SC
760mm	730mm	755mm	HYSP76SC
800mm	770mm	795mm	HYSP80SC
900mm	870mm	895mm	HYSP90SC
1000mm	970mm	995mm	HYSP100SC

Please note, when using a side panel, the maximum door adjustment is reduced by 25mm.

## HYDRO EXPRESS - PROFILE EXTENSION

DESCRIPTION	CODE - SILVER
30mm Compensating Wall Profile	HYCB30SC



EXCEPTIONAL  
EVERYDAY.

PIVOT DOOR WITH  
SEMI FRAMED SIDE PANEL



EXCEPTIONAL  
EVERYDAY.



# FLAIR FRAMELESS

Flair Frameless delivers an affordable 6mm glass solution without compromising on quality. Featuring a rising-butt hinge, it ensures smooth opening and closing while preventing seals from dragging or wearing against the floor – perfect for long-term durability.

This cleverly designed collection is suitable for both wetroom and shower tray application.

FINISHES:

SILVER

MATTE BLACK

## KEY FEATURES

<p><b>6mm</b></p> <p>TOUGHENED SAFETY GLASS</p>	<p><b>1950mm</b></p> <p>HEIGHT</p>	<p>UP TO <b>50mm</b></p> <p>PRODUCT ADJUSTMENT</p>	
<p>SILVER &amp; MATTE BLACK OPTIONS AVAILABLE SELECTED DOOR STYLES</p>	<p>UP TO 25mm WALL PROFILE EXTENSION AVAILABLE</p>	<p>CLEAN EASY GLASS COATING</p>	<p>RISING BUTT HINGE MECHANISM FOR SMOOTH MOVEMENT</p>
<p>SPARE PARTS AVAILABLE</p>	<p>REVERSIBLE FOR LEFT OR RIGHT HANDED INSTALLATION</p>	<p>EASY ACCESS SOLUTION</p>	<p>20 YEAR GUARANTEE</p>

# FLAIR FRAMELESS SALOON DOOR\*

FINISHES:

SILVER **MATT BLACK**



SALOON DOOR IN  
ALCOVE - SILVER

## FLAIR FRAMELESS - SALOON DOOR

SIZE (mm)	ADJUSTMENT SIZE		ACCESS (mm)	CODE	
	MIN (mm)	MAX (mm)		SILVER	BLACK
800	750	800	594	FFSD80SC	FFSD80BC
900	850	900	694	FFSD90SC	FFSD90BC
1000	950	1000	794	FFSD100SC	FFSD100BC
1200	1150	1200	994	FFSD120SC	FFSD120BC

## FLAIR FRAMELESS - SEMI FRAMED SIDE PANELS

SIZE (mm)	ADJUSTMENT SIZE		CODE	
	MIN (mm)	MAX (mm)	SILVER	BLACK
700	665	690	FFSP70SC	FFSP70BC
760	725	750	FFSP76SC	-
800	765	790	FFSP80SC	FFSP80BC
900	865	890	FFSP90SC	FFSP90BC
1000	965	990	FFSP100SC	FFSP100BC
1200	1165	1190	FFSP120SC	FFSP120BC

## FLAIR FRAMELESS - INLINE PANELS

SIZE (mm)	CODE	
	SILVER	BLACK
200	FFIL20SC	FFIL20BC
300	FFIL30SC	FFIL30BC
400	FFIL40SC	FFIL40BC

## FLAIR FRAMELESS - PROFILE EXTENSION

DESCRIPTION	CODE	
	SILVER	BLACK
10mm Compensating Wall Profile	FFCB10SC	FFCB10BG
25mm Compensating Wall Profile	FFCB25SC	FFCB25BG



\*Discontinued once stock is sold.



SALOON DOOR  
IN ALCOVE - BLACK

# FLAIR FRAMELESS PIVOT DOOR\*

FINISHES:

SILVER MATT BLACK



PIVOT DOOR WITH SEMI FRAMED SIDE PANEL - SILVER

## FLAIR FRAMELESS - PIVOT DOOR

SIZE (mm)	ADJUSTMENT SIZE		ACCESS (mm)	CODE	
	MIN (mm)	MAX (mm)		SILVER	BLACK
700	650	700	513	FFPD70SC	FFPD70BC
800	750	800	613	FFPD80SC	FFPD80BC
900	850	900	713	FFPD90SC	FFPD90BC
1000	950	1000	813	FFPD100SC	FFPD100BC

## FLAIR FRAMELESS - SEMI FRAMED SIDE PANELS

SIZE (mm)	ADJUSTMENT SIZE		CODE	
	MIN (mm)	MAX (mm)	SILVER	BLACK
700	665	690	FFSP70SC	FFSP70BC
760	725	750	FFSP76SC	-
800	765	790	FFSP80SC	FFSP80BC
900	865	890	FFSP90SC	FFSP90BC
1000	965	990	FFSP100SC	FFSP100BC
1200	1165	1190	FFSP120SC	FFSP120BC

## FLAIR FRAMELESS - INLINE PANELS

SIZE (mm)	CODE	
	SILVER	BLACK
200	FFIL20SC	FFIL20BC
300	FFIL30SC	FFIL30BC
400	FFIL40SC	FFIL40BC

## FLAIR FRAMELESS - PROFILE EXTENSION

DESCRIPTION	CODE	
	SILVER	BLACK
10mm Compensating Wall Profile	FFCB10SC	FFCB10BG
25mm Compensating Wall Profile	FFCB25SC	FFCB25BG



\*Discontinued once stock is sold.



PIVOT DOOR IN ALCOVE - BLACK

# FLAIR FRAMELESS CORNER PIVOT DOOR\*

FINISHES:

SILVER



SLEEK POLISHED  
CHROME HANDLES

## FLAIR FRAMELESS - CORNER PIVOT DOOR

SIZE (mm)	ADJUSTMENT SIZE		ACCESS (mm)	CODE SILVER
	MIN (mm)	MAX (mm)		
800	765	790	935	FFCPD80SC
900	865	890	1076	FFCPD90SC
1000	965	990	1217	FFCPD100SC

## FLAIR FRAMELESS - OFFSET CORNER PIVOT DOOR

SIZE (mm)	ADJUSTMENT SIZE		ACCESS (mm)	CODE SILVER
	MIN (mm)	MAX (mm)		
1000 x 800	765-965	790-990	640	FFCPD100X80SC
1200 x 800	765-1165	790-1190	640	FFCPD120X80SC
1200 x 900	865-1165	890-1190	740	FFCPD120X90SC

\*Discontinued once stock is sold.



CORNER PIVOT DOOR - SILVER

# FLAIR FRAMELESS HINGED ROTATING WETROOM PANEL\*

FINISHES:

SILVER



## FLAIR FRAMELESS - CURVED HINGED WETROOM PANEL

SIZE (mm)	ADJUSTMENT SIZE		CODE SILVER
	MIN (mm)	MAX (mm)	
900	875	900	FFCRR90SC

\*Discontinued once stock is sold.



HINGED ROTATING  
WETROOM PANEL - SILVER

# FLAIR FRAMELESS HINGED ROTATING WETROOM PANEL\*

FINISHES:

SILVER



## FLAIR FRAMELESS - HINGED ROTATING WETROOM PANEL

SIZE (mm)	ADJUSTMENT SIZE		CODE
	MIN (mm)	MAX (mm)	
300	300	325	FFPD30SC
450	450	475	FFPD45SC
600	600	625	FFPD60SC

\*Discontinued once stock is sold.



HINGED ROTATING  
WETROOM PANEL - SILVER



EXCEPTIONAL  
EVERYDAY.



# SLIMLINE CAPELLA

Slimline Capella is the ultimate solution to making installation simple. With a selection of doors that boasts a total adjustment of up to 100mm, Slimline Capella offers flexibility with adjustable wall profiles allowing the shower enclosure to fit perfectly even when the walls are not completely plum.

With adjustable wall profiles for a perfect fit and a silent roller mechanism for smooth, quiet operation, the collection is a dependable, and the hassle-free solution.

### FINISHES:

SILVER

### KEY FEATURES:

<b>6mm</b> TOUGHENED SAFETY GLASS	<b>1950mm</b> HEIGHT	UP TO <b>100mm</b> PRODUCT ADJUSTMENT
PATENTED TWIST + LOCK ADJUSTMENT MECHANISM	25mm WALL PROFILE EXTENSION AVAILABLE	CLEAN EASY GLASS COATING
SPARE PARTS AVAILABLE	REVERSIBLE FOR LEFT OR RIGHT HANDED INSTALLATION	20 YEAR GUARANTEE

# SLIMLINE CAPELLA PIVOT DOOR

FINISHES:

SILVER



## SLIMLINE CAPELLA - PIVOT DOOR

SIZE (mm)	ADJUSTMENT SIZE		ACCESS (mm)	CODE SILVER
	MIN (mm)	MAX (mm)		
800	700	800	422	STPD80SC
900	800	900	530	STPD90SC
1000	900	1000	630	STPD100SC
1200	1100	1200	630	STPD120SC

## SLIMLINE CAPELLA - SEMI FRAMED SIDE PANELS

SIZE (mm)	ADJUSTMENT SIZE		CODE SILVER
	MIN (mm)	MAX (mm)	
700	670	690	STSP70SC
760	730	750	STSP76SC
800	770	790	STSP80SC
900	870	890	STSP90SC
1000	970	990	STSP100SC
1100	1070	1090	STSP110SC
1200	1170	1190	STSP120SC

## SLIMLINE CAPELLA - PROFILE EXTENSION

DESCRIPTION	CODE SILVER
25mm Compensating Wall Profile	STPACKDSC



SLEEK POLISHED CHROME HANDLES



MINIMALIST CHROME PROFILES AND PIVOT HINGE



EXCEPTIONAL  
EVERYDAY.

PIVOT DOOR WITH SEMI FRAMED SIDE PANEL - SILVER

# SLIMLINE CAPELLA SLIDING DOOR

FINISHES:

SILVER



UP TO  
100 mm  
PRODUCT ADJUSTMENT

## SLIMLINE CAPELLA - SLIDING DOOR

SIZE (mm)	ADJUSTMENT SIZE		ACCESS (mm)	CODE SILVER
	MIN (mm)	MAX (mm)		
1000	940	1000	365	STSA100SC
1100	1040	1100	428	STSA110SC
1200	1140	1200	478	STSA120SC
1300	1200	1300	528	STSA130SC
1400	1300	1400	578	STSA140SC
1500	1400	1500	628	STSA150SC

## SLIMLINE CAPELLA - SEMI FRAMED SIDE PANELS

SIZE (mm)	ADJUSTMENT SIZE		CODE SILVER
	MIN (mm)	MAX (mm)	
700	670	690	STSP70SC
760	730	750	STSP76SC
800	770	790	STSP80SC
900	870	890	STSP90SC
1000	970	990	STSP100SC
1100	1070	1090	STSP110SC
1200	1170	1190	STSP120SC

## SLIMLINE CAPELLA - PROFILE EXTENSION

DESCRIPTION	CODE SILVER
25mm Compensating Wall Profile	STPACKDSC



QUICK RELEASE  
DOUBLE ROLLERS



SLEEK  
POLISHED  
CHROME  
HANDLES

EXCEPTIONAL  
EVERYDAY.

SLIDING DOOR IN ALCOVE - SILVER

# SLIMLINE CAPELLA

## CORNER ENTRY & OFFSET CORNER ENTRY

FINISHES:

SILVER



### SLIMLINE CAPELLA - CORNER ENTRY

DESCRIPTION	ADJUSTMENT SIZE MIN	MAX	ACCESS	CODE - SILVER
700mm	650mm	700mm	325mm	STCE70SSC
800mm	740mm	800mm	383mm	STCE80SSC
900mm	840mm	900mm	454mm	STCE90SSC
1000mm	940mm	1000mm	524mm	STCE100SSC
1200mm	1140mm	1200mm	524mm	STCE120SSC

### SLIMLINE CAPELLA - OFFSET CORNER ENTRY

DESCRIPTION	ADJUSTMENT SIZE MIN	MAX	ACCESS	CODE - SILVER
700 x 800mm	650-700mm	740-800mm	335mm	STCE70x80SSC
700 x 900mm	650-700mm	840-900mm	370mm	STCE70x90SSC
700 x 1000mm	650-700mm	940-1000mm	407mm	STCE70x100SSC
700 x 1200mm	650-700mm	1140-1200mm	425mm	STCE70x120SSC
800 x 900mm	740-800mm	840-900mm	405mm	STCE80x90SSC
800 x 1000mm	740-800mm	940-1000mm	442mm	STCE80x100SSC
800 x 1200mm	740-800mm	1140-1200mm	462mm	STCE80x120SSC
900 x 1000mm	840-900mm	940-1000mm	493mm	STCE90x100SSC
900 x 1200mm	840-900mm	1140-1200mm	493mm	STCE90x120SSC



SLEEK POLISHED  
CHROME HANDLES



OFFSET CORNER ENTRY



EXCEPTIONAL  
EVERYDAY.

CORNER ENTRY

# SLIMLINE CAPELLA BIFOLD DOOR

FINISHES:

SILVER



## SLIMLINE CAPELLA - BIFOLD DOOR

SIZE (mm)	ADJUSTMENT SIZE MIN (mm)	ADJUSTMENT SIZE MAX (mm)	ACCESS (mm)	CODE SILVER
700	630	700	358	STBF70SC*
800	730	800	428	STBF80SC
900	800	900	498	STBF90SC
1000	900	1000	578	STBF100SC
1100	1000	1100	578	STBF110SC
1200	1100	1200	578	STBF120SC

## SLIMLINE CAPELLA - SEMI FRAMED SIDE PANELS

SIZE (mm)	ADJUSTMENT SIZE MIN (mm)	ADJUSTMENT SIZE MAX (mm)	CODE SILVER
700	670	690	STSP70SC
760	730	750	STSP76SC
800	770	790	STSP80SC
900	870	890	STSP90SC
1000	970	990	STSP100SC
1100	1070	1090	STSP110SC
1200	1170	1190	STSP120SC

## SLIMLINE CAPELLA - PROFILE EXTENSION

DESCRIPTION	CODE SILVER
25mm Compensating Wall Profile	STPACKDSC



SLEEK POLISHED CHROME HANDLES



BIFOLD HINGE

EXCEPTIONAL  
EVERYDAY.

BIFOLD DOOR WITH SEMI FRAMED SIDE PANEL - SILVER

\*Discontinued once stock is sold.

# SLIMLINE CAPELLA

## 2 DOOR QUADRANT & OFFSET QUADRANT

FINISHES:

SILVER



SLIMLINE CAPELLA - 2 DOOR QUADRANT

### SLIMLINE CAPELLA - 2 DOOR QUADRANT

DESCRIPTION	ADJUSTMENT SIZE MIN	MAX	ACCESS	CODE - SILVER
800mm	750mm	800mm	370mm	STCQ80SC
900mm	850mm	900mm	514mm	STCQ90SC
1000mm	950mm	1000mm	514mm	STCQ100SC*

### SLIMLINE CAPELLA - 2 DOOR OFFSET QUADRANT

DESCRIPTION	ADJUSTMENT SIZE MIN	MAX	ACCESS	CODE - SILVER
900 x 800mm	750-800mm	850-900mm	446mm	STCQ80x90SC
1000 x 800mm	750-800mm	950-1000mm	446mm	STCQ80x100SC*
1200 x 900mm	850-900mm	1150-1200mm	514mm	STCQ90x120SC*

\*Discontinued once stock is sold.



SLEEK POLISHED CHROME HANDLES



MINIMALIST CHROME PLATED PROFILES



SLIMLINE CAPELLA - 2 DOOR OFFSET QUADRANT

EXCEPTIONAL  
EVERYDAY.

# SOUL

## PREMIUM GRAB BAR COLLECTION

A stylish collection of chrome plated stainless steel grab bars to complement your bathroom.



BLACK RUBBER GRIP OPTION



GREY RUBBER GRIP OPTION

### KEY FEATURES:

 <b>S304</b> STAINLESS STEEL	 <b>200KG</b> LOAD TEST	 25MM OR 32MM BAR DIAMETER
 CONCEALED FIXINGS	 NON SLIP RUBBER GRIP OPTIONS AVAILABLE	 S304 STAINLESS STEEL SCREWS INCLUDED
	 10 YEAR GUARANTEE	

# SOUL

## STRAIGHT GRAB BARS\* - CHROME PLATED STAINLESS STEEL

### CHROME GRAB BAR 30cm

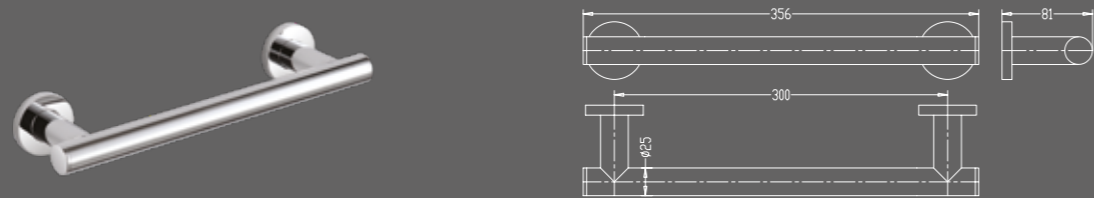

### CHROME GRAB BAR 45cm

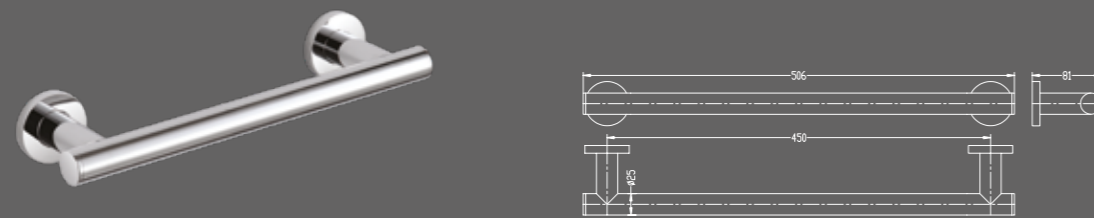

### CHROME GRAB BAR 60cm

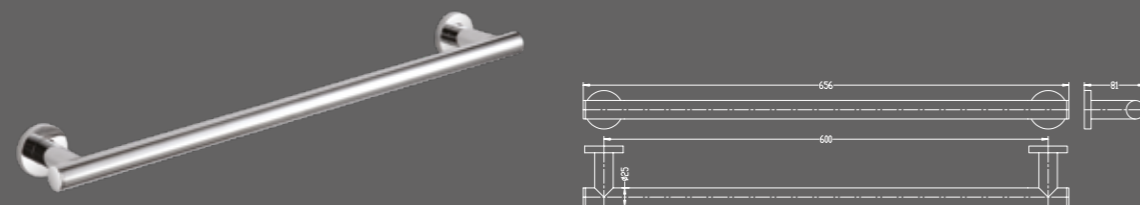

#### 25MM DIAMETER CHROME GRAB BARS

DESCRIPTION	CODE - CHROME
Grab Bar 30cm	SOGBS30S
Grab Bar 45cm	SOGBS45S
Grab Bar 60cm	SOGBS60S

#### 32MM DIAMETER CHROME GRAB BARS

DESCRIPTION	CODE - CHROME
Grab Bar 30cm	SOGB32S30S
Grab Bar 45cm	SOGB32S45S
Grab Bar 60cm	SOGB32S60S

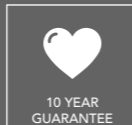
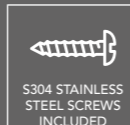
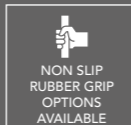

\*Discontinued once stock is sold.

## STRAIGHT GRAB BARS\*

WITH RUBBER GRIP OPTION (25MM DIAMETER)

### CHROME GRAB BAR 30cm – with choice of Black or Grey Rubber Grip

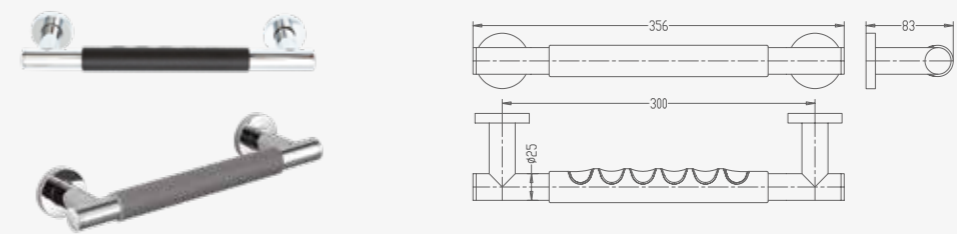

### CHROME GRAB BAR 45cm – with choice of Black or Grey Rubber Grip

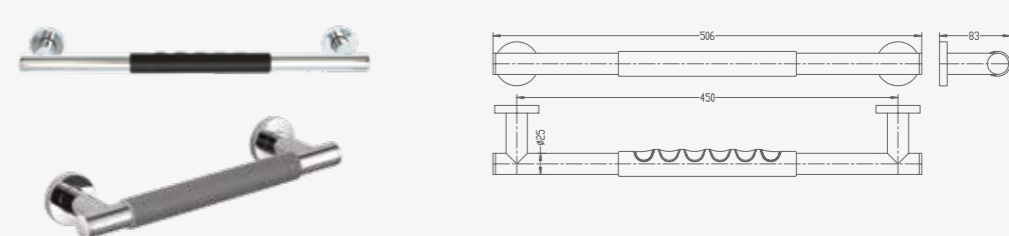

### CHROME GRAB BAR 60cm – with choice of Black or Grey Rubber Grip

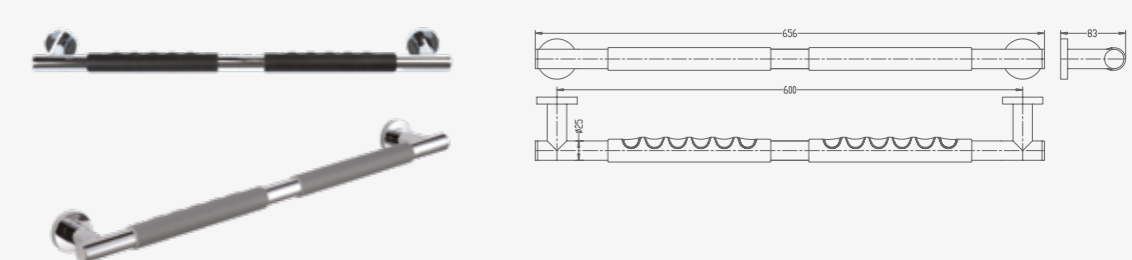

DESCRIPTION	CODE - CHROME
Grab Bar 30cm – with Black Rubber Grip	SOGBS30SB
Grab Bar 30cm – with Grey Rubber Grip	SOGBS30SG
Grab Bar 45cm – with Black Rubber Grip	SOGBS45SB
Grab Bar 45cm – with Grey Rubber Grip	SOGBS45SG
Grab Bar 60cm – with Black Rubber Grip	SOGBS60SB
Grab Bar 60cm – with Grey Rubber Grip	SOGBS60SG

\*Discontinued once stock is sold.

# SOUL

## 135° ANGLED BARS\* - CHROME PLATED STAINLESS STEEL

### LEFT HAND

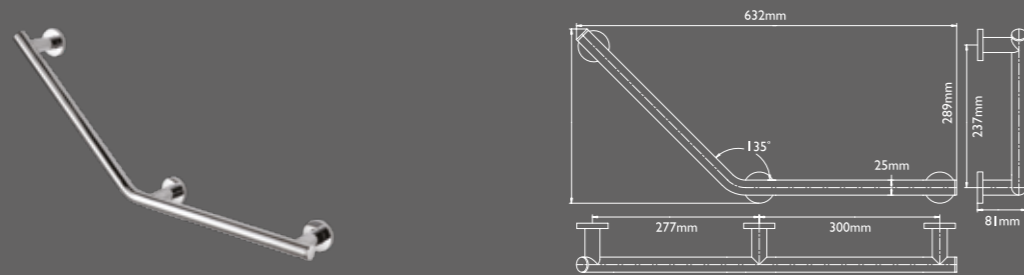

### RIGHT HAND

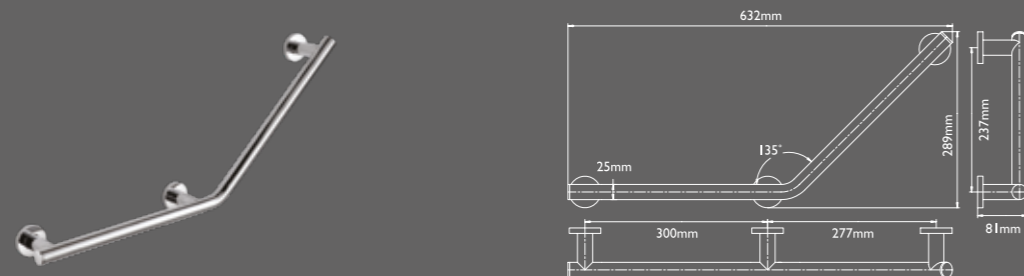

### UNIVERSAL WITH BASKET - SUITS LEFT OR RIGHT HAND APPLICATION

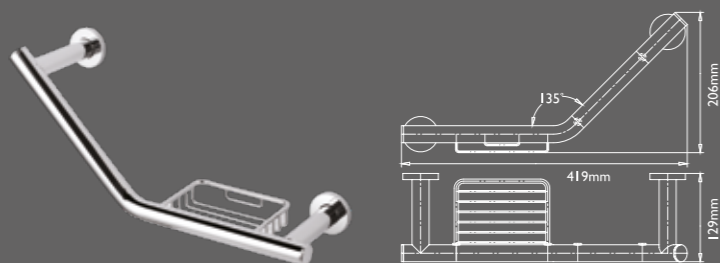

#### 25MM DIAMETER 135° ANGLED GRAB BARS

DESCRIPTION	CODE - CHROME
135° Grab Bar - Left Hand	SOGBI35LS
135° Grab Bar - Right Hand	SOGBI35RS
135° Grab Bar - Universal With Basket	SOGBABS

#### 32MM DIAMETER 135° ANGLED GRAB BARS

DESCRIPTION	CODE - CHROME
135° Angled Grab Bar (32mm diameter)	SOGB32135S

- S304 STAINLESS STEEL**
- 200KG** LOAD TEST
- 25mm OR 32mm BAR DIAMETER
- CONCEALED FIXINGS
- NON SLIP RUBBER GRIP OPTIONS AVAILABLE
- S304 STAINLESS STEEL SCREWS INCLUDED
- 10 YEAR GUARANTEE

\*Discontinued once stock is sold.

## 135° ANGLED BARS\*

WITH RUBBER GRIP OPTION (25MM DIAMETER)

### LEFT HAND – with Black Rubber Grip



### RIGHT HAND – with Black Rubber Grip



### LEFT HAND – with Grey Rubber Grip



### RIGHT HAND – with Grey Rubber Grip

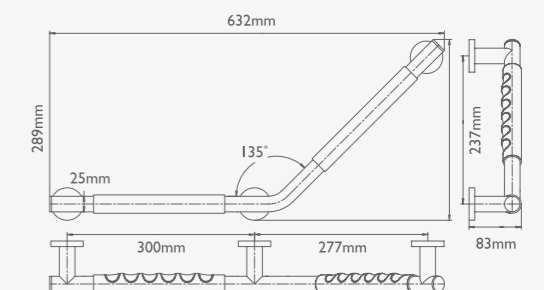
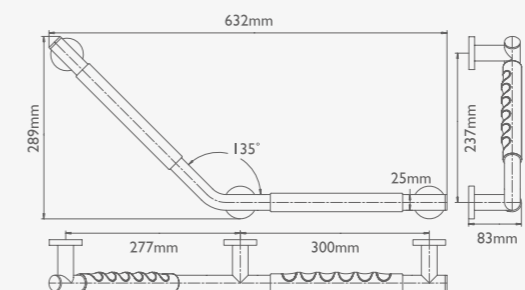

DESCRIPTION	CODE - CHROME
135° Grab Bar – Left Hand with Black Rubber Grip	SOGBI35LSB
135° Grab Bar – Right Hand with Black Rubber Grip	SOGBI35RSB
135° Grab Bar – Left Hand with Grey Rubber Grip	SOGBI35LSG
135° Grab Bar – Right Hand with Grey Rubber Grip	SOGBI35RSG

\*Discontinued once stock is sold.

# SOUL

## 90° ANGLED BARS\* - CHROME PLATED STAINLESS STEEL

### LEFT HAND

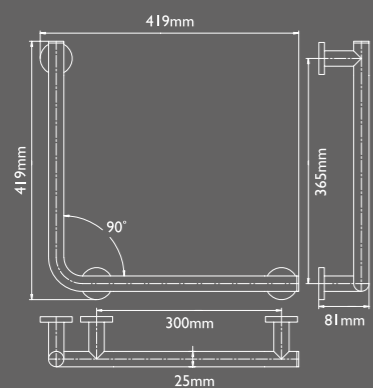

### RIGHT HAND

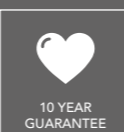
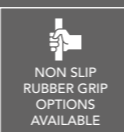
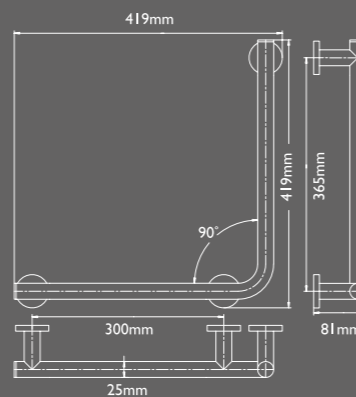

#### 25MM DIAMETER 90° ANGLED GRAB BARS

DESCRIPTION	CODE - CHROME
90° Grab Bar - Left Hand (32mm Diameter)	SOGB90LS
90° Grab Bar - Right Hand (32mm Diameter)	SOGB90RS

#### 32MM DIAMETER 90° ANGLED GRAB BARS

DESCRIPTION	CODE - CHROME
90° Grab Bar - Left Hand (32mm Diameter)	SOGB3290LS
90° Grab Bar - Right Hand (32mm Diameter)	SOGB3290RS

\*Discontinued once stock is sold.

## 90° ANGLED BARS\*

WITH RUBBER GRIP OPTION (25MM DIAMETER)

### LEFT HAND

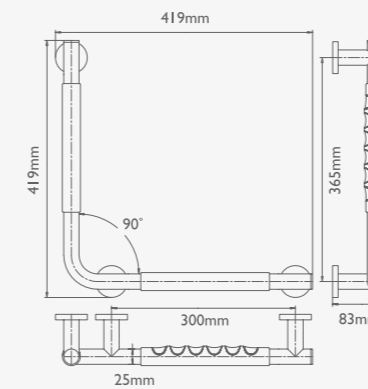

### RIGHT HAND

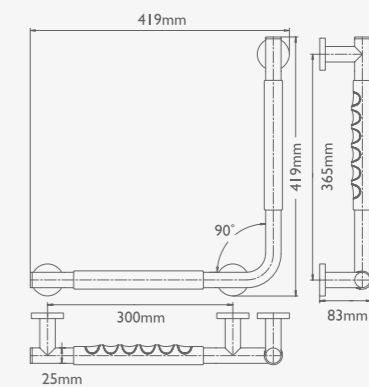

DESCRIPTION	CODE - CHROME
90° Grab Bar – Left Hand with Black Rubber Grip	SOGB90LSB*
90° Grab Bar – Right Hand with Black Rubber Grip	SOGB90RSB
90° Grab Bar – Right Hand with Grey Rubber Grip	SOGB90RSG
90° Grab Bar – Right Hand with Grey Rubber Grip	SOGB90RSG

\*Discontinued once stock is sold.

# TRAYS

Extensive selection of shower tray shapes and sizes to complement your bathroom.

## SHOWER TRAY INSTALLATION

All shower trays must be installed as per instructions supplied. Install on a base of fine sand, cement and cement additive. Please note: Silicone sealants, foams, mastics, installation compound adhesive or similar must not be used as a substitute for cement. Ensure shower tray is 100% level and water test to ensure water is draining correctly. If not satisfied at any stage do not proceed with fitting.

Fitting of Shower Tray is acceptance of quality.

## KEY FEATURES

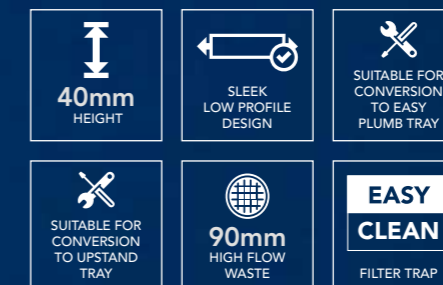

EXCEPTIONAL  
EVERYDAY.

# SLIMLINE SHOWER TRAYS



Extensive selection of shower tray shapes and sizes to complement your bathroom.

- Strong and rigid construction
- Manufactured to British Standard BS6340/5
- Tough high gloss ABS acrylic capped surface finish
- Easy-to-clean and maintain

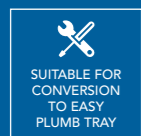
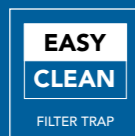

**NOTE:** It is normal for a small amount of localised water to be retained on a shower tray surface after use. This should be wiped dry to prevent any build up of residue.



SLIMLINE RECTANGLE TRAY INCLUDING SHOWER WASTE



SLIMLINE SQUARE TRAY INCLUDING SHOWER WASTE



SLIMLINE QUADRANT TRAY INCLUDING SHOWER WASTE



SLIMLINE OFFSET QUADRANT TRAY INCLUDING SHOWER WASTE (right hand illustrated)



OFFSET QUADRANT LEFT HAND

OFFSET QUADRANT RIGHT HAND

#### SHOWER TRAY INSTALLATION

All shower trays must be installed as per instructions supplied. Please note: Silicone sealants, foams, mastics, installation compound adhesive etc. must not be used as a substitute for cement. Ensure shower tray is installed 100% level and water test to ensure it is draining correctly. Fitting of Shower Tray is acceptance of quality.

\*1200 x 1000mm Slimline Rectangle Tray is acrylic only.

## SLIMLINE RECTANGLE

PRODUCT DESCRIPTION	CODE
800 x 700mm Slimline Rectangle Tray	TSL8070R
900 x 700mm Slimline Rectangle Tray	TSL9070R
900 x 760mm Slimline Rectangle Tray	TSL9076R
900 x 800mm Slimline Rectangle Tray	TSL9080R
1000 x 700mm Slimline Rectangle Tray	TSL10070R
1000 x 760mm Slimline Rectangle Tray	TSL10076R
1000 x 800mm Slimline Rectangle Tray	TSL10080R
1000 x 900mm Slimline Rectangle Tray	TSL10090R
1100 x 700mm Slimline Rectangle Tray	TSL11070R
1100 x 760mm Slimline Rectangle Tray	TSL11076R
1100 x 800mm Slimline Rectangle Tray	TSL11080R
1100 x 900mm Slimline Rectangle Tray	TSL11090R
1200 x 700mm Slimline Rectangle Tray	TSL12070R
1200 x 760mm Slimline Rectangle Tray	TSL12076R
1200 x 800mm Slimline Rectangle Tray	TSL12080R
1200 x 900mm Slimline Rectangle Tray	TSL12090R
1200 x 1000mm Slimline Rectangle Tray	TSL120100R*
1300 x 800mm Slimline Rectangle Tray	TSL13080R
1300 x 900mm Slimline Rectangle Tray	TSL13090R
1400 x 700mm Slimline Rectangle Tray	TSL14070R
1400 x 760mm Slimline Rectangle Tray	TSL14076R
1400 x 800mm Slimline Rectangle Tray	TSL14080R
1400 x 900mm Slimline Rectangle Tray	TSL14090R
1500 x 700mm Slimline Rectangle Tray	TSL15070R
1500 x 760mm Slimline Rectangle Tray	TSL15076R
1500 x 800mm Slimline Rectangle Tray	TSL15080R
1500 x 900mm Slimline Rectangle Tray	TSL15090R
1600 x 700mm Slimline Rectangle Tray	TSL16070R
1600 x 800mm Slimline Rectangle Tray	TSL16080R
1600 x 900mm Slimline Rectangle Tray	TSL16090R
1700 x 700mm Slimline Rectangle Tray	TSL17070R
1700 x 750mm Slimline Rectangle Tray	TSL17075R
1700 x 800mm Slimline Rectangle Tray	TSL17080R
1700 x 900mm Slimline Rectangle Tray	TSL17090R
1800 x 800mm Slimline Rectangle Tray	TSL18080R
1800 x 900mm Slimline Rectangle Tray	TSL18090R
2000 x 900mm Slimline Rectangle Tray	TSL20090R

# SLIMLINE SHOWER TRAYS

## SLIMLINE SQUARE

PRODUCT DESCRIPTION	CODE
700 x 700mm Slimline Square Tray	TSL70S
760 x 760mm Slimline Square Tray	TSL76S
800 x 800mm Slimline Square Tray	TSL80S
900 x 900mm Slimline Square Tray	TSL90S
1000 x 1000mm Slimline Square Tray	TSL100S
1200 x 1200mm Slimline Square Tray	TSL120S

## SLIMLINE QUADRANT

PRODUCT DESCRIPTION	CODE
800 x 800mm Slimline Quadrant Tray	TSL80Q
900 x 900mm Slimline Quadrant Tray	TSL90Q
1000 x 1000mm Slimline Quadrant Tray	TSL100Q

## SLIMLINE OFFSET QUADRANT

PRODUCT DESCRIPTION	CODE
900 x 760mm Offset Quadrant Tray - Left	TSL9076LOQ
900 x 760mm Offset Quadrant Tray - Right	TSL9076ROQ
900 x 800mm Offset Quadrant Tray - Left	TSL9080LOQ
900 x 800mm Offset Quadrant Tray - Right	TSL9080ROQ
1000 x 800mm Offset Quadrant Tray - Left	TSL10080LOQ
1000 x 800mm Offset Quadrant Tray - Right	TSL10080ROQ
1000 x 900mm Offset Quadrant Tray - Left	TSL10090LOQ
1000 x 900mm Offset Quadrant Tray - Right	TSL10090ROQ
1100 x 800mm Offset Quadrant Tray - Left	TSL11080LOQ
1100 x 800mm Offset Quadrant Tray - Right	TSL11080ROQ
1100 x 900mm Offset Quadrant Tray - Left	TSL11090LOQ
1100 x 900mm Offset Quadrant Tray - Right	TSL11090ROQ
1200 x 800mm Offset Quadrant Tray - Left	TSL12080LOQ
1200 x 800mm Offset Quadrant Tray - Right	TSL12080ROQ
1200 x 900mm Offset Quadrant Tray - Left	TSL12090LOQ
1200 x 900mm Offset Quadrant Tray - Right	TSL12090ROQ



SLIMLINE SQUARE TRAY INCLUDING SHOWER WASTE



SLIMLINE QUADRANT TRAY INCLUDING SHOWER WASTE



SLIMLINE OFFSET QUADRANT TRAY INCLUDING SHOWER WASTE (right hand illustrated)



SLIMLINE OFFSET QUADRANT TRAY INCLUDING SHOWER WASTE (left hand illustrated)

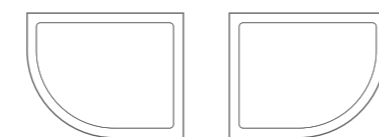

OFFSET QUADRANT LEFT HAND

OFFSET QUADRANT RIGHT HAND

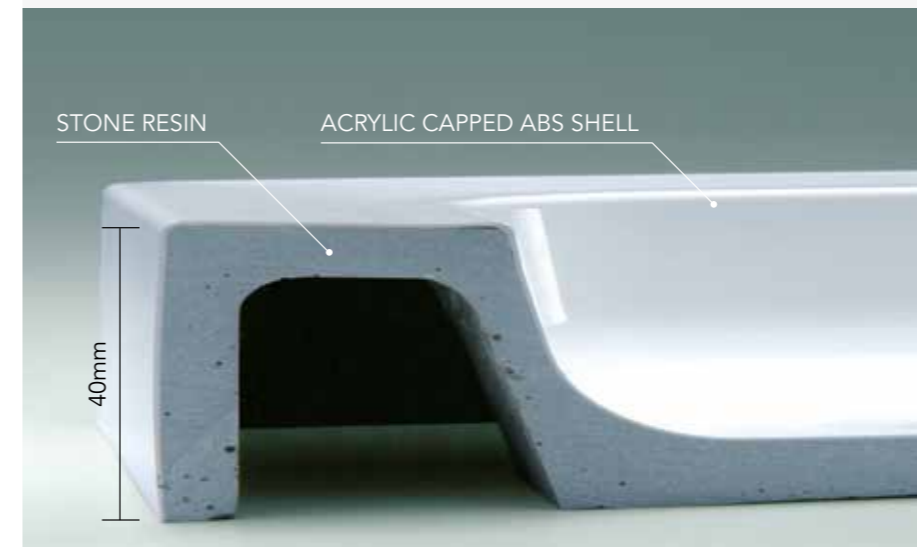

- 40mm HEIGHT
- SLEEK LOW PROFILE DESIGN
- 90mm HIGH FLOW WASTE
- EASY CLEAN FILTER TRAP
- SUITABLE FOR CONVERSION TO EASY PLUMB TRAY

## SLIMLINE CORNER SHOWER TRAY WASTES

PRODUCT DESCRIPTION	CODE
800 x 800mm Slimline Quadrant Tray - Corner Waste	CTSL80Q
900 x 900mm Slimline Quadrant Tray - Corner Waste	CTSL90Q
1000 x 1000mm Slimline Quadrant Tray - Corner Waste	CTSL100Q
800 x 800mm Slimline Square Tray - Corner Waste	CTSL80S
900 x 900mm Slimline Square Tray - Corner Waste	CTSL90S
1000 x 1000mm Slimline Square Tray - Corner Waste*	CTSL100S*
900 x 800mm Slimline Rectangle Tray - Corner Waste	CTSL9080R
1000 x 800mm Slimline Rectangle Tray - Corner Waste	CTSL10080R
1200 x 800mm Slimline Rectangle Tray - Corner Waste	CTSL12080R
1200 x 900mm Slimline Rectangle Tray - Corner Waste	CTSL12090R

### SHOWER TRAY INSTALLATION

All shower trays must be installed as per instructions supplied. Please note: Silicone sealants, foams, mastics, installation compound adhesive etc. must not be used as a substitute for cement. Ensure shower tray is installed 100% level and water test to ensure it is draining correctly. Fitting of Shower Tray is acceptance of quality.

\*Discontinued once stock is sold.

**NOTE:** It is normal for a small amount of localised water to be retained on a shower tray surface after use. This should be wiped dry to prevent any build up of residue.

# ANTI-SLIP SHOWER TRAYS

**NOTE:** It is normal for a small amount of localised water to be retained on a shower tray surface after use. This should be wiped dry to prevent any build up of residue.

## ANTI-SLIP SLIMLINE RECTANGLE

PRODUCT DESCRIPTION	CODE
Anti-Slip Slimline Rectangle Tray 1000 x 800mm	ASTSLI0080R
Anti-Slip Slimline Rectangle Tray 1000 x 900mm	ASTSLI0090R
Anti-Slip Slimline Rectangle Tray 1100 x 800mm	ASTSLI1080R
Anti-Slip Slimline Rectangle Tray 1100 x 900mm	ASTSLI1090R
Anti-Slip Slimline Rectangle Tray 1200 x 700mm	ASTSLI2070R
Anti-Slip Slimline Rectangle Tray 1200 x 760mm	ASTSLI2076R
Anti-Slip Slimline Rectangle Tray 1200 x 800mm	ASTSLI2080R
Anti-Slip Slimline Rectangle Tray 1200 x 900mm	ASTSLI2090R
Anti-Slip Slimline Rectangle Tray 1400 x 700mm	ASTSLI4070R
Anti-Slip Slimline Rectangle Tray 1400 x 800mm	ASTSLI4080R
Anti-Slip Slimline Rectangle Tray 1400 x 900mm	ASTSLI4090R
Anti-Slip Slimline Rectangle Tray 1500 x 700mm	ASTSLI5070R
Anti-Slip Slimline Rectangle Tray 1500 x 800mm	ASTSLI5080R
Anti-Slip Slimline Rectangle Tray 1500 x 900mm	ASTSLI5090R
Anti-Slip Slimline Rectangle Tray 1600 x 700mm	ASTSLI6070R
Anti-Slip Slimline Rectangle Tray 1600 x 800mm	ASTSLI6080R
Anti-Slip Slimline Rectangle Tray 1600 x 900mm	ASTSLI6090R
Anti-Slip Slimline Rectangle Tray 1700 x 700mm	ASTSLI7070R
Anti-Slip Slimline Rectangle Tray 1700 x 800mm	ASTSLI7080R
Anti-Slip Slimline Rectangle Tray 1700 x 900mm	ASTSLI7090R

- Anti-slip coating for extra safety in the showering space
- Pendulum slip tested, in accordance with British Standard BS7976:2
- Classified as low slip potential



**SHOWER TRAY INSTALLATION**  
All shower trays must be installed as per instructions supplied. Please note: Silicone sealants, foams, mastics, installation compound adhesive etc. must not be used as a substitute for cement. Ensure shower tray is installed 100% level and water test to ensure it is draining correctly. Fitting of Shower Tray is acceptance of quality.

## ANTI-SLIP SLIMLINE SQUARE

PRODUCT DESCRIPTION	CODE
Anti-Slip Slimline Square Tray 800mm	ASTSL80S
Anti-Slip Slimline Square Tray 900mm	ASTSL90S
Anti-Slip Slimline Square Tray 1000mm	ASTSL100S

## ANTI-SLIP SLIMLINE QUADRANT

PRODUCT DESCRIPTION	CODE
Anti-Slip Slimline Quadrant Tray 800mm	ASTSL80Q
Anti-Slip Slimline Quadrant Tray 900mm	ASTSL90Q
Anti-Slip Slimline Quadrant Tray 1000mm	ASTSL100Q

**40mm**  
HEIGHT

ANTI SLIP SURFACE

**90mm**  
HIGH FLOW WASTE

**EASY CLEAN**

FILTER TRAP

SUITABLE FOR CONVERSION TO EASY PLUMB TRAY

SLEEK LOW PROFILE DESIGN

## ANTI-SLIP OFFSET QUADRANT

PRODUCT DESCRIPTION	CODE
Anti-Slip Slimline Offset Quadrant Tray 1000 x 800mm - Left	ASTSLI0080LOQ
Anti-Slip Slimline Offset Quadrant Tray 1000 x 800mm - Right	ASTSLI0080ROQ
Anti-Slip Slimline Offset Quadrant Tray 1000 x 900mm - Left	ASTSLI0090LOQ
Anti-Slip Slimline Offset Quadrant Tray 1000 x 900mm - Right	ASTSLI0090ROQ
Anti-Slip Slimline Offset Quadrant Tray 1200 x 800mm - Left	ASTSLI2080LOQ
Anti-Slip Slimline Offset Quadrant Tray 1200 x 800mm - Right	ASTSLI2080ROQ
Anti-Slip Slimline Offset Quadrant Tray 1200 x 900mm - Left	ASTSLI2090LOQ
Anti-Slip Slimline Offset Quadrant Tray 1200 x 900mm - Right	ASTSLI2090ROQ

## ANTI-SLIP SLIMLINE - TRAYS WITH CORNER WASTE

PRODUCT DESCRIPTION	CODE
900 x 900mm - Quadrant Tray - Inc. Corner Waste	CASTSL90Q
1000 x 1000mm Quadrant Tray - Inc. Corner Waste	CASTSL100Q
900 x 900mm - Square Tray - Inc. Corner Waste	CASTSL90S
1000 x 1000mm - Square Tray - Inc. Corner Waste	CASTSL100S
1000 x 800mm - Rectangle Tray - Inc. Corner Waste	CASTSLI0080R
1200 x 800mm - Rectangle Tray - Inc. Corner Waste	CASTSLI2080R
1200 x 900mm - Rectangle Tray - Inc. Corner Waste	CASTSLI2090R



RECTANGLE TRAY CORNER WASTE



SQUARE TRAY CORNER WASTE



900mm QUADRANT TRAY CORNER WASTE



800mm QUADRANT TRAY CORNER WASTE

# 25MM ULTRA SLIM SHOWER TRAYS\*

# 25MM ANTI-SLIP ULTRA SLIM SHOWER TRAYS\*

## RECTANGLE

PRODUCT DESCRIPTION	CODE
Ultra Slim Rectangle Tray 1000 x 800mm - Inc.Waste & White Grill	USLI0080R
Ultra Slim Rectangle Tray 1000 x 900mm - Inc.Waste & White Grill	USLI0090R
Ultra Slim Rectangle Tray 1200 x 800mm - Inc.Waste & White Grill	USLI2080R
Ultra Slim Rectangle Tray 1200 x 900mm - Inc.Waste & White Grill	USLI2090R
Ultra Slim Rectangle Tray 1400 x 800mm - Inc.Waste & White Grill	USLI4080R
Ultra Slim Rectangle Tray 1400 x 900mm - Inc.Waste & White Grill	USLI4090R
Ultra Slim Rectangle Tray 1500 x 800mm - Inc.Waste & White Grill	USLI5080R
Ultra Slim Rectangle Tray 1500 x 900mm - Inc.Waste & White Grill	USLI5090R
Ultra Slim Rectangle Tray 1600 x 800mm - Inc.Waste & White Grill	USLI6080R
Ultra Slim Rectangle Tray 1600 x 900mm - Inc.Waste & White Grill	USLI6090R
Ultra Slim Rectangle Tray 1700 x 800mm - Inc.Waste & White Grill	USLI7080R
Ultra Slim Rectangle Tray 1700 x 900mm - Inc.Waste & White Grill	USLI7090R
Ultra Slim Rectangle Tray 1800 x 800mm - Inc.Waste & White Grill	USLI8080R
Ultra Slim Rectangle Tray 1800 x 900mm - Inc.Waste & White Grill	USLI8090R

## SQUARE

PRODUCT DESCRIPTION	CODE
Ultra Slim Square Tray 800 x 800mm - Inc.Waste & White Grill	USL80S
Ultra Slim Square Tray 900 x 900mm - Inc.Waste & White Grill	USL90S
Ultra Slim Square Tray 1000 x 1000mm - Inc.Waste & White Grill	USL100S

## QUADRANT & OFFSET QUADRANT

PRODUCT DESCRIPTION	CODE
Ultra Slim Quadrant Tray 800 x 800mm	USL80Q
Ultra Slim Quadrant Tray 900 x 900mm	USL90Q
Ultra Slim Offset Quadrant Tray 1000 x 800mm Left Hand - Inc.Waste & White Grill	USLI0080LOQ
Ultra Slim Offset Quadrant Tray 1000 x 800mm Right Hand - Inc.Waste & White Grill	USLI0080ROQ
Ultra Slim Offset Quadrant Tray 1200 x 800mm Left Hand - Inc.Waste & White Grill	USLI2080LOQ
Ultra Slim Offset Quadrant Tray 1200 x 800mm Right Hand - Inc.Waste & White Grill	USLI2080ROQ
Ultra Slim Offset Quadrant Tray 1200 x 900mm Left Hand - Inc.Waste & White Grill	USLI2090LOQ
Ultra Slim Offset Quadrant Tray 1200 x 900mm Right Hand - Inc.Waste & White Grill	USLI2090ROQ

## NEW - ULTRA SLIM TRAY GRILLS

PRODUCT DESCRIPTION	CODE
Ultra Slim Tray Grill - <b>Brushed Brass</b>	USLTGBB
Ultra Slim Tray Grill - <b>Matte Black</b>	USLTGMB
Ultra Slim Tray Grill - <b>White</b>	USLTGW

\*Discontinued once stock is sold.

## RECTANGLE

PRODUCT DESCRIPTION	CODE
Anti-Slip Ultra Slim Rectangle Tray 1200 x 800mm - Inc.Waste & White Grill	AUSLI2080R
Anti-Slip Ultra Slim Rectangle Tray 1200 x 800mm - Inc.Waste & White Grill	AUSLI2080R
Anti-Slip Ultra Slim Rectangle Tray 1200 x 900mm - Inc.Waste & White Grill	AUSLI2090R
Anti-Slip Ultra Slim Rectangle Tray 1400 x 800mm - Inc.Waste & White Grill	AUSLI4080R
Anti-Slip Ultra Slim Rectangle Tray 1400 x 900mm - Inc.Waste & White Grill	AUSLI4090R
Anti-Slip Ultra Slim Rectangle Tray 1500 x 800mm - Inc.Waste & White Grill	AUSLI5080R
Anti-Slip Ultra Slim Rectangle Tray 1600 x 800mm - Inc.Waste & White Grill	AUSLI6080R
Anti-Slip Ultra Slim Rectangle Tray 1600 x 900mm - Inc.Waste & White Grill	AUSLI6090R
Anti-Slip Ultra Slim Rectangle Tray 1700 x 800mm - Inc.Waste & White Grill	AUSLI7080R
Anti-Slip Ultra Slim Rectangle Tray 1700 x 900mm - Inc.Waste & White Grill	AUSLI7090R

## SQUARE

PRODUCT DESCRIPTION	CODE
Anti-Slip Ultra Slim Square Tray 900 x 900mm - Inc.Waste & White Grill	AUSL90S

Discontinued once stock is sold.



ULTRA SLIM RECTANGLE TRAY INCLUDING WASTE AND WHITE GRILL



ULTRA SLIM SQUARE TRAY INCLUDING WASTE AND WHITE GRILL



ULTRA SLIM QUADRANT TRAY INCLUDING WASTE AND WHITE GRILL



ULTRA SLIM OFFSET QUADRANT TRAY INCLUDING WASTE AND WHITE GRILL

# SLIMLINE SHOWER TRAYS WITH TILING UPSTAND

# WASTES & SHOWER TRAP WASTES

## SLIMLINE - SQUARE TRAY WITH UPSTAND

SIZE	CODE
760 x 760mm - Inc. Waste	TSL76SU
800 x 800mm - Inc. Waste	TSL80SU
900 x 900mm - Inc. Waste	TSL90SU

## SLIMLINE - RECTANGLE TRAY WITH UPSTAND

SIZE	CODE
900 x 760mm - Inc. Waste	TSL9076RU
1000 x 760mm - Inc. Waste	TSL10076RU
1000 x 800mm - Inc. Waste	TSL10080RU
1200 x 760mm - Inc. Waste	TSL12076RU
1200 x 800mm - Inc. Waste	TSL12080RU
1200 x 900mm - Inc. Waste	TSL12090RU
1400 x 800mm - Inc. Waste	TSL14080RU
1400 x 900mm - Inc. Waste	TSL14090RU
1700 x 750mm - Inc. Waste*	TSL17075RU*

## SLIMLINE - QUADRANT TRAY WITH UPSTAND

SIZE	CODE
800 x 800mm - Inc. Waste	TSL80QU
900 x 900mm - Inc. Waste	TSL90QU

## SLIMLINE - TRAYS WITH CORNER WASTE

SIZE	CODE
800 x 800mm - Quadrant Tray - Inc. Corner Waste	CTSL80Q
900 x 900mm - Quadrant Tray - Inc. Corner Waste	CTSL90Q
1000 x 1000mm - Quadrant Tray - Inc. Corner Waste	CTSL100Q
800 x 800mm - Square Tray - Inc. Corner Waste	CTSL80S
900 x 900mm - Square Tray - Inc. Corner Waste	CTSL90S
900 x 800mm - Rectangle Tray - Inc. Corner Waste	CTSL9080R
1000 x 800mm - Rectangle Tray - Inc. Corner Waste	CTSL10080R
1200 x 800mm - Rectangle Tray - Inc. Corner Waste	CTSL12080R
1200 x 900mm - Rectangle Tray - Inc. Corner Waste	CTSL12090R

\*Discontinued once stock is sold.

## WASTES

### MCALPINE WASTES

PRODUCT DESCRIPTION	COLOUR	CODE
McAlpine 90mm Shower Waste with Plastic Dome	White	ST90WH10-70
McAlpine 90mm Shower Waste with Plastic Dome	Matte Black	ST90MB10-70



## SHOWER TRAP WASTES

Further enhance the look of your shower tray with our **NEW** 90mm High Flow Shower Waste featuring a modern and stylish finish.

Constructed from brass and plated in the following colours; **Brushed Brass, Brushed Copper, Brushed Nickel, Matte Black and Matte White.**

### NEW - 90MM SLIM TRAY WASTES

PRODUCT DESCRIPTION	COLOUR	CODE
90mm Slim Tray Waste	Brushed Brass	TSLWASTEBB
90mm Slim Tray Waste	Brushed Copper	TSLWASTEBC
90mm Slim Tray Waste	Brushed Nickel	TSLWASTEBN
90mm Slim Tray Waste	Matte Black	TSLWASTEMB
90mm Slim Tray Waste	White	TSLWASTEMW



# EASY PLUMB KIT SUITS ALL SLIMLINE SHOWER TRAYS

Slimline Easy Plumb shower kits have adjustable legs for compliant installation and future waste access without compromising style. Any Flair slimline tray can be used with the kit, increasing tray height by 95mm.



DESCRIPTION	WEIGHT	CODE
Easy Plumb Riser Kit For All Square Trays & Rectangle Trays (Suitable for maximum tray size of 1200mm)	2kg	WD3
Easy Plumb Riser Kit For All Quadrant Trays (Suitable for maximum tray size of 1200 x 900mm)	3kg	WD4
Easy Plumb Riser Kit For All Square Trays & Rectangle Trays (Suitable for maximum tray size of 2000mm)	2kg	WD5
Viva Shower Waste	1kg	TSLWASTE

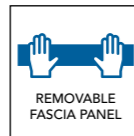
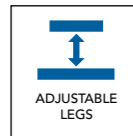
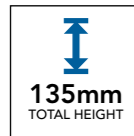

# PROSEAL WATERPROOF BARRIER SEAL

Flexible up-stand seal installed onto shower trays, baths and worktops eliminating the risk of water leakage.

## PROSEAL

PRODUCT DESCRIPTION	CODE
ProSeal 2 metre Roll	PROS2.0M
ProSeal 2.5 metre Roll	PROS2.5M
ProSeal 3 metre Roll	PROS3.0M
ProSeal 3.5 metre Roll	PROS3.5M
ProSeal 4 metre Roll	PROS4.0M
ProSeal 10 metre Roll	PROS10.0M
ProSeal 20 metre Roll	PROS20.0M

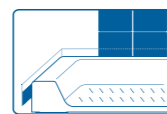

# SHOWER FIXING KITS

## A SIMPLE SOLUTION TO BAR VALVE INSTALLATIONS



### PL8 SHOWER FIXING KIT

Designed for new builds and first-fix installations. It provides fast, accurate pipe positioning and a strong, reliable base for installing bar shower mixers on new pipework.

- Reduce installation time
- No depth measuring - fits any tile thickness
- Verify pipe alignment before tiling or fitting bar valve
- Chamfered compression nuts for clean, controlled tightening
- Anti-skew plate maintains perfect alignment
- Reliable 150mm centres to suit most bar-type mixers
- Withstands 130kg direct pull force

### PL4 SHOWER FIXING KIT

Designed for existing bathrooms and replacement showers. The PL4 kit offers precise installation and a secure fixing to existing pipework using high-quality components.

- Chrome finish
- Reduces installation time
- Secures existing pipework
- Solid brass construction
- Four fixing points per pipe
- Chamfered compression nuts for controlled tightening
- Supplied with premium stainless steel shrouds

# SHOWER TRAY SHAPES

FIND YOUR PERFECT FIT



SQUARE



RECTANGLE



QUADRANT



OFFSET QUADRANT LEFT HAND



OFFSET QUADRANT RIGHT HAND

# SHOWER DOOR STYLES

DESIGNED TO FIT YOUR SPACE



SLIDING DOOR



CORNER ENTRY



OFFSET QUADRANT



PIVOT DOOR



QUADRANT



BIFOLD DOOR

# AT A GLANCE METRIC CONVERTER

NOMINAL GUIDE ONLY

METRIC (MM)	FEET (FT)	INCHES (INS)
700	2 ft 3.5	27.5
760	2 ft 6.0	30
800	2 ft 7.5	31.5
900	2 ft 11.4	35.5
1000	3 ft 3.5	39.5
1100	3 ft 7.3	43.3
1200	3 ft 11.2	47.2

# SHOWER DOOR MEASURING GUIDE

Note: Your measurements should be taken after tray installation and tiling.  
The space left after tiling will determine the shower door size required.

## FOR A RECESS

Measurement at low point \_\_\_\_\_

Measurement at high point \_\_\_\_\_

\* Two measures relevant for uneven walls to ensure shower door caters for adjustment width needed

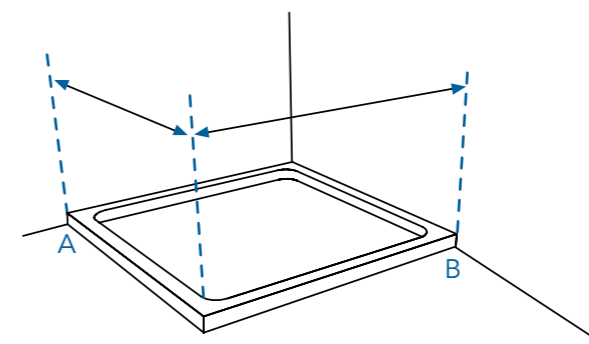
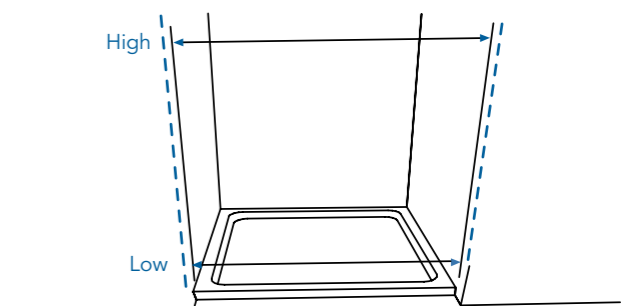

## FOR A CORNER

Measure to acute edge of shower tray

Measurement A \_\_\_\_\_ B \_\_\_\_\_

## FOR A QUADRANT\*

Radius Guide	
Distance 'C' (mm)	Radius (mm)
207	500
218	525
228	550

\*All Flair Quadrant and Offset Quadrant trays have a 550mm radius.

Timbers placed at right angles to determine C

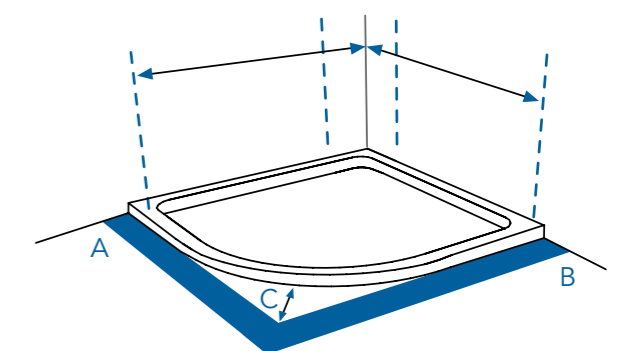

Measurement

A \_\_\_\_\_ B \_\_\_\_\_ C \_\_\_\_\_

# SPECIFICATION COMPARISON...

A selection of our product features and specifications are summarised below to help you select the right collection for every installation.



	<b>VERVE PRO 8</b> Page 12	<b>VERVE PRO</b> Page 22	<b>VERVE PRO WETROOMS</b> Page 40	<b>VERVE PRO BATHSCREENS</b> Page 44		<b>HYDRO EXPRESS</b> Page 54	<b>FLAIR FRAMELESS</b> Page 66	<b>SLIMLINE CAPELLA</b> Page 78	
GLASS THICKNESS	Up to 8mm	6mm	8mm	6 + 8mm		GLASS THICKNESS	Up to 6mm	6mm	6mm
DOOR HEIGHT	1950mm	1900mm	2000mm	Up to 1500mm		DOOR HEIGHT	1850mm	1950mm	1950mm
FITTING / ASSEMBLY			-	-		FITTING / ASSEMBLY		-	
ADJUSTMENT	Up to 50mm	Up to 50mm	Up to 15mm	Up to 15mm		ADJUSTMENT	Up to 50mm	Up to 50mm	Up to 100mm
FINISHES						FINISHES			
ROLLER WHEELS	Quick Release Double Wheel	Quick Release Double Wheel	-	-		ROLLER WHEELS	Quick Release Single Wheel	-	Quick Release Double Wheel
GLASS COATING	Clearvue	Clearvue	Clearvue	Clearvue		GLASS COATING	ClearVue	Clean Easy	Clean Easy
COVER CAPS	Chrome / Black Plated	Chrome / Black Plated	Chrome / Black Plated	Chrome / Black Plated		COVER CAPS	Chrome Plated	Chrome / Black Plated	Chrome Plated
PVC-CLEAR SEALS	YES	YES	YES	YES		PVC-CLEAR SEALS	YES	YES	YES
SHOWER TRAY COMPATIBLE	YES	YES	YES	YES		SHOWER TRAY COMPATIBLE	YES	YES	YES
WETROOM COMPATIBLE	YES	YES	YES	-		WETROOM COMPATIBLE	-	YES	-
GUARANTEE	20 Years	20 Years	20 Years	20 Years		GUARANTEE	10 Years	20 Years	20 Years

# QUALITY GUARANTEED

## QUALITY GUARANTEED

At Flair we have an unwavering commitment to product quality.

All Flair products are CE approved. All glass is toughened safety glass and produced to EN12150. Flair products are performance tested to EN14428, ensuring the highest industry criteria is met.

All glass is toughened safety glass and produced to EN12150. Flair products are performance tested to EN14428, ensuring the highest industry criteria is met.

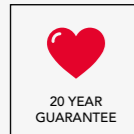

### Essential Collections

Essential Collections are covered by a 20 year guarantee against manufacturer defect excluding Hydro Express.

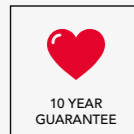

Hydro Express is covered by a 10 year guarantee against manufacturer defect.

This guarantee is valid on condition that the goods are installed and maintained in accordance with the products fitting instructions and best practices.

Non glass and detachable parts such as rollers, seals etc. are subject to normal wear and tear during usage and are under guarantee for 24 months from time of purchase.

Please complete your product guarantee card included in the components box or register online at [flairshowers.com/register](http://flairshowers.com/register).

**Note: Proof of purchase is necessary to validate your guarantee so retain purchase receipt for your Flair product.**

If a Flair shower enclosure is defective in materials or manufacture, please contact us on +353 42 966 8000.

## CLEANEASY & CLEARVUE GLASS TREATMENT SYSTEM

Essential Collections shower doors, wetroom panels and bathscreens are supplied with a special glass coating designed to reduce limescale build up and make cleaning the glass easier.



## AFTERSALES & SPARE PARTS SERVICE

Flair is 100% committed to customer service excellence.

We carry a full range of spare parts for each product range and have dedicated aftersales specialists to deal with any issues you may have.

If you have any queries, please contact Flair on +353 42 966 8000.

## RETURN POLICY

**Flair will not accept return of any product that has been opened.**

We do not accept return of any product if the packaging has been damaged.

If the product is unopened and not damaged, we will accept the return of the product but a handling fee of 25% of the invoice will be charged.

## SHOWER DOOR INSTALLATION ADVICE

**BEFORE YOU INSTALL YOUR SHOWER ENCLOSURE PLEASE READ ALL INSTRUCTIONS. FAILURE TO DO SO MAY LEAD TO INVALIDATION OF YOUR GUARANTEE.**

Flair Showers Ltd will not accept responsibility for any loss or damage, however caused, if the shower enclosure has not been installed as per the instructions.

- The shower tray MUST be fitted 100% level. The shower tray must be sealed correctly to prevent any water leakage.
- Glass edges are vulnerable and should be treated with care at all times. Contact with hard surfaces may result in glass breakage if due care is not taken.
- Check walls for electrical cabling or water pipes before drilling.
- Your shower enclosure, Bathscreen or wetroom must be inspected before installation. Check for all visual defects on the product before installation. Once the enclosure has been installed no claims of damage or defect will be accepted. Fitting of shower enclosure is acceptance of quality.
- The wall plugs supplied with the shower door are for use in solid walls. Timber frame, stud partition walls will require alternative fixings.
- Ensure vertical wall profiles are level and are an equal distance in from the tray.
- Shower Doors, Wetroom Screens, Bathscreens and Side Panels are adjustable between the dimensions stated. All dimensions are approximate.
- Ensure adjustment at wall profiles are equal at both sides and that all screws are fully tightened.
- Ensure hinges are level and securely fitted to the glass.
- Ensure magnets are the right orientation and are attracting rather than repelling.
- The shower enclosure should be sealed on the outside only using silicone sealant.

- Care must be taken during assembly. Flair will not accept responsibility where incorrect assembly results in undue stress being put on any components in this product.
- If there are any manufacturer defects, please call Flair Service Line on 0800 180 8050.
- Note: If a problem has been caused by incorrect installation, a call-out charge will apply for the Flair technical engineer's time. Subsequent charges will apply "to fix" a problem caused by incorrect installation.

## BATHSCREEN INSTALLATION

The Bathscreen must be installed on a 100% level surface with the bath edge free from obstructions.

Bathscreens should not be used on a bath with roll top rim, stepped edge rim or where the bath handle void meets the Bathscreen seal. This will impact on the performance of the bathscreen and the guarantee will be void. The Bathscreen should be fitted to the inside edge of the bath only.

A Bathscreen acts as a water deflector and is not 100% waterproof. If used appropriately under normal showering conditions and installed to the inside edge of the bath, water will be deflected into the showering area. Bathscreens are not suitable for power showers.

## SHOWER TRAY INSTALLATION

All shower trays must be installed as per instructions supplied. Install on a base of fine sand, cement and cement additive. Please note: Silicone sealants, foams, mastics, installation compound adhesive or similar must not be used as a substitute for cement. Ensure shower tray is 100% level and water test to ensure water is draining correctly. If not satisfied at any stage do not proceed with fitting. Fitting of Shower Tray is acceptance of quality.

NOTE: It is normal for a small amount of localised water to be retained on a shower tray surface after use. This should be wiped dry to prevent any build up of residue.

## CLEANING GUIDELINES

- Glass: Use a soft cloth and mild detergent, rinse off thoroughly.
- Metallic Surfaces: Use a soft cloth and warm soapy water. Rinse off thoroughly.
- Do not use "Spray & leave" cleaning products on the metal surface as these will cause damage to your product. These include acidic based cleaning products, bleaches, solvents or abrasive pads. Only use detergents, cleaners and limescale removers with a pH of 5-8.
- The constant use of detergents will degrade the finish of the product over time if not thoroughly rinsed off.
- In hard water areas, regular cleaning of your Flair door will help to prevent the build-up of limescale. Stubborn deposits of limescale can be removed with the use of a mild limescale remover.
- Check your shower door for functionality periodically. Ensure that the wheel track is free from any grit/dirt which may have collected over time.

## CONDITIONS OF SALE

Unless otherwise stated, all quotations are subject to acceptance within 30 days of date of issue. Other than in the case of faulty goods / incorrect despatch, Flair will not accept the return of any product.

**As part of our continuing policy of product improvement, we reserve the right to amend specifications, colours and s without prior notice. Images are for illustrative purposes only. The colours and finishes shown in the catalogue are as accurate as possible within the limits of the printing process. The positioning of all shower heads and shower wastes in the brochure is for illustrative purposes only.**

\*Errors and Omissions Exempt.



**JOIN OUR EXCLUSIVE WHATSAPP GROUP**

Stay updated on our latest locations and events. Get real-time updates and join us when we're in your area.





**CLICK FIT  
PRO**

**INSTALLERS  
CHOICE**

*"We are committed to supporting installers with high-quality products that make their jobs easier and more efficient. Flair PRO is engineered with innovations that simplify installations and is trusted for its reliability and performance. We are proud to be the installer's choice."*

Johnny O'Callaghan  
SALES DIRECTOR

# NEPTUNE

Neptune shower pods guarantee a Leak-Free shower experience, providing unmatched water protection and showering with absolute peace of mind.



## LEAK-FREE FOR LIFE

- ✓ Strong & Durable
- ✓ Anti-bacterial
- ✓ Easy to Install
- ✓ Fitted to Walls
- ✓ Completely Encapsulated
- ✓ No Tiling
- ✓ No Grouting
- ✓ No Staining
- ✓ No Mould
- ✓ No Limescale Build-up

**SCAN FOR MORE INFORMATION**  
+353 01 825 0840



NEPTUNELEAKFREE.COM





flair  
—

Flair Showers

Northern Ireland  
+353 42 966 8000

[sales@flairshowers.com](mailto:sales@flairshowers.com)



[FLAIRSHOWERS.COM](http://FLAIRSHOWERS.COM)

