

5.

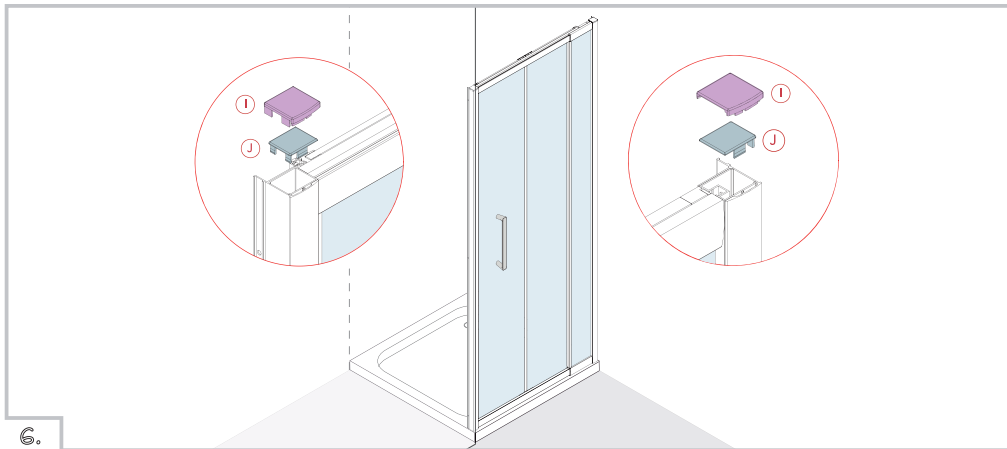

6.

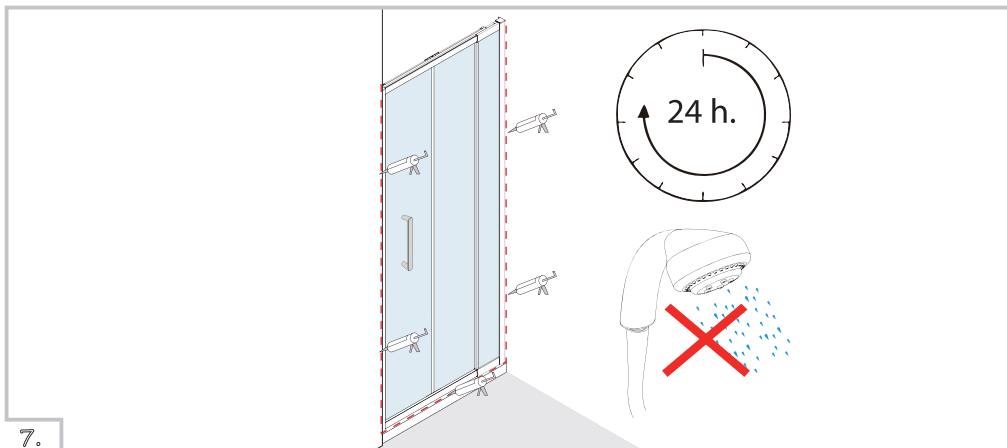

7.

Flair Showers Ltd. Baillieborough, Co. Cavan, Ireland. Sales Office Direct Telephone: +353 42 9665294  
 Where a shower enclosure has been installed contrary to these instructions Flair Showers Ltd cannot accept liability for any consequential loss or damage.  
[www.flairshowers.com](http://www.flairshowers.com)



# NEW SLIMLINE CAPELLA *flair* TELESCOPIC



## BIFOLD Shower Enclosure

Thank you for choosing a Flair product.

Flair Showers Ltd. is EN ISO 9001:2000 certified

This product is fully compliant with EN14428  
 (European Standard for Functional Requirements and Test Methods for Shower Enclosures)

### BEFORE YOU INSTALL YOUR CAPELLA SHOWER ENCLOSURE PLEASE READ ALL INSTRUCTIONS. FAILURE TO DO SO MAY LEAD TO INVALIDATION OF YOUR WARRANTY





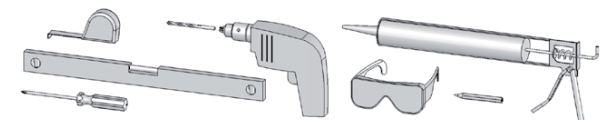





- The shower tray **MUST** be fitted level, tiled in and sealed along its entire wall length.
- Glass door edges are vulnerable. Contact with hard surfaces may result in glass breakage.
- The shower enclosure should be sealed on the outside using silicone sealant.
- Check walls for electrical cabling or water pipes before drilling.

Tools required  
 to install your  
 shower  
 enclosure



# Slimline Capella

## Installation Instructions

ITEM		Quant.
(C)		1 Pc
(D)	 4X40	6 Pc
(E)		6 Pc
(F)		12 Pc
(G)	 4X10	6 Pc
(H)		12 Pc
(I)		1+1 Pc
(J)		2 Pc
(K)		1+1 Pc
(L)		1 Pc

